

## Instruction Manual

### BODY COMPOSITION ANALYZER

# MC-580M

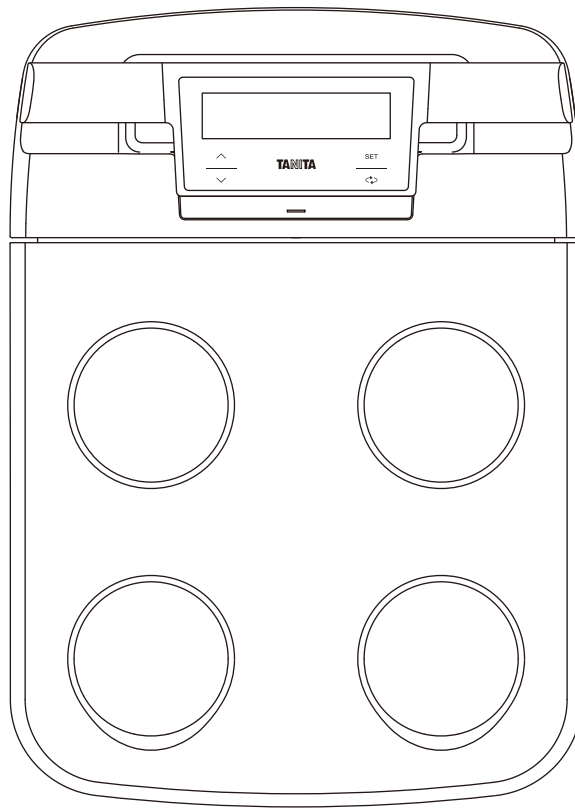

Images in this manual are for illustration purposes only.

#### <Usage Conditions>

Temperature Range	: 5 to 35°C/41 to 95°F
Relative Humidity Range	: 30 to 80% (non-condensing)
Max Altitude	: 2,000m ASL/6500ft ASL
Atmospheric Pressure Range	: 86 to 106kPa

#### <Storage/Transport Conditions>

Temperature Range	: -10 to 60°C/14 to 140°F
Relative Humidity Range	: 10 to 90% (non-condensing)
Atmospheric Pressure Range	: 70 to 106kPa

To avoid malfunctions, avoid storing the equipment in a place with direct sunlight, significant temperature changes, a risk of dampness, a large amount of dust or a risk of vibration or impact, or in the vicinity of flames.



Please read this Instruction Manual carefully and keep it for future reference.

# Intended Use

MC-580M is a medical device to measure body composition, such as the percentage of body fat (fat percentage), using a noninvasive method on Bioelectrical Impedance Analysis (BIA), intended for the following use

- medical screening and health assessments
- monitoring the progress of weight loss during medical treatment relating to lifestyle diseases such as diabetes, hyperlipidemia, bariatric surgery, hypertension and fatty liver disease.

# Efficacy

This product has been specifically designed to be simple to use and required no additional user assistance to take a measurement.

Measurements can be taken in under 30 seconds for maximum convenience.

# Contents

## Before Use

For Your Safety .....	4
Part Names & Connection Procedure .....	8
Power Supply .....	10
Preparations before Use .....	11

## How to Use

Taking Measurements .....	13
Taking Measurements without Registering .....	17
Measurement Results .....	20
Settings .....	22

## If Necessary

Troubleshooting .....	27
Specifications .....	28

# For Your Safety

en

Before use

This section explains precautionary measures to be taken to avoid injury to the patients and operators of this equipment, and to prevent damage to property. Please familiarise yourself with this information to ensure safe operation of this equipment. The MC-580M is not diagnostic equipment. In order to make an accurate diagnosis, in addition to the result of MC-580M, the doctor in charge should conduct appropriate examinations and consider the results.

## Contraindication

This equipment must not be used on subjects with pacemakers or other mechanical implants.

This equipment passes a weak electrical current through the body which could interfere with and cause the malfunction of electrical medical implants, resulting in serious harm.



 **Warning** Failure to follow instructions highlighted with this mark could result in death or severe injury.

 **Caution** Failure to follow instructions highlighted with this mark could result in injury or damage to property.



Prohibited

This mark indicates actions that are prohibited.



Required

This mark indicates instructions that must always be followed.

## Warning

**Do not handle the plug with wet hands.**

This may result in electric shock, fire, or current leakage. When using batteries, please do not touch the DC jack.



Prohibited

**Do not modify this equipment.**

There is a risk of electrocution or injury, and precise analysis cannot be guaranteed.



**Do not use multiple adapters.**

This may result in fire.

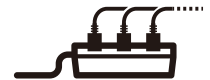

**Do not use the equipment if you have any kind of wound or inflammation on any part of your body that comes into direct contact with the equipment.**

## Caution



Prohibited

**Do not allow the equipment to get wet.**

**Avoid using on subjects with allergies to metals.**

Allergic reactions may be caused by the stainless steel used in the electrodes of this equipment.

**Do not jump on the equipment.**

**Do not tilt the equipment.**

**Do not use this equipment near other products that emit electromagnetic waves.**

**Do not insert fingers into any of the gaps or holes.**

**Do not apply force to the display.**

The screen may break and cause injury.

**Do not place items sensitive to magnetic forces near the equipment.**

The magnet of the impedance meter may corrupt data on devices such as USB memory sticks if these are placed near the equipment.

**Assist persons with disabilities.**

Another person should assist persons with disabilities who may not be able to take a measurement alone.

**Do not use the monitor if you have any kind of wound or inflammation on any part of your body that comes into direct contact with the monitor.**

**Do not use rechargeable batteries.**

**Do not use old batteries together with new batteries, or a mix of different types of batteries at the same time.**

Doing so may cause battery fluid to leak or the batteries to become excessively hot and rupture, resulting in damage to the equipment or injury.

**Be sure that the batteries are inserted in the corrected orientation.**

If the batteries are inserted incorrectly, fluid may leak from the batteries and damage the floor.



Required

**Clean the equipment after each use.**

Wipe off the equipment if dust accumulates or it becomes dirty.

**Stand clear of the subject during measurement to ensure accuracy.**

**Continually monitor both the subject and the equipment for anomalies.**

If an anomaly in the subject or equipment is discovered, take appropriate action, such as stopping the equipment, while ensuring the safety of the subject.

**Use the included AC adapter (ATM012T-W090V).**

**Do not lean against the equipment.**

**Unplug the AC adapter from the equipment when moving it.**

**Interpretation of analysis results (e.g. evaluation of measurements and formulation of exercise programs based on results) must be performed by a professional.**

Weight loss measures and exercise based on self-analysis could be harmful to your health. Always follow the advice of a qualified professional.

**This equipment is designated a Class B IT device (mainly for systems intended to be used in indoor environments) and is CE (EMC) certified, but it may affect devices that are sensitive to electromagnetic waves.**

If connecting a computer or peripheral devices to this equipment, please use devices complying with IEC60601-1 (EN60601-1). Power must be supplied from a medical isolation transformer for IEC60950 (EN60950) devices. Keep a distance of 1.5m between units during operation. Failure to do so may cause electric shock to subjects or malfunction.

**If you do not intend to use this equipment for a long period of time, or if you always use AC adapter, remove the batteries before storage.**

# For Your Safety (continued)

en

Before use



## For Accurate Measurements



Prohibited

**Avoid measuring after strenuous exercise.**

This may cause inaccurate measurements. Please take measurements after sufficient rest.



**Avoid measuring after over-eating or over-drinking, or when severely dehydrated.**

This may cause inaccurate measurements. For greater accuracy, avoid using directly after waking up. Use at the same time of day each time, at least three hours after the last meal.



**Ensure arms are not touching sides and inner thighs are not touching each other during measurement. If necessary, place a dry towel between arm and side and/or between thighs.**

**Do not take measurements while using transmitting devices such as mobile phones, as these may affect readings.**



Required

**Use the equipment under the same conditions and in the same position as much as possible for accurate tracking of changes.**

Readings are affected by the level of hydration and position of the body. Please use at the same time of day each time, under the same conditions and in the same body position.



**Avoid measuring in multiple locations with greatly differing temperatures.**

This may cause inaccurate measurements. Allow the equipment to stand for at least 2 hours before using if it is moved to a new location with a temperature difference of 20°C/36°F or more.



**Place palms, fingers and soles of feet in the correct positions on the electrodes when measuring.**

Improper contact between the hands or feet and electrodes may cause the displayed fat percentage to be lower than the actual percentage, or cause an error.



<Child>

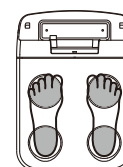

<Adult>

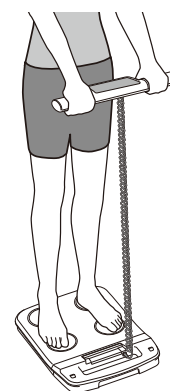

**Stand barefoot on the equipment after thoroughly washing hands and feet.**

Proper measurements cannot be taken if wearing socks or if the palms or soles of the feet are dirty.

**Do not sit or bend the elbows or knees.**

This causes inaccurate measurements.

**Do not move during measurement.**

This causes inaccurate measurements.

**Use in a stable location.**

Errors in measurements may occur if the equipment is used in an unstable location.

**For further accuracy and security, please position the two adjustable feet on the base until they just make contact with the floor.**

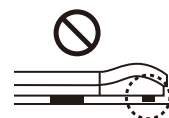
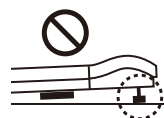

### Note

For people to whom any of the following apply, changes in measurement values should be referred to as a reference.

- People with metal implants
- People taking medications that induce changes in body water (e.g. diuretics, etc.)
- People who are pregnant, on dialysis or experiencing any swelling. The reliability of body fat percentages may decrease.
- Normal measurements cannot be performed for people with hard surfaces on their heel (stratum corneum). Moisten the sole before measuring.

# Regular Maintenance



Required

**TANITA recommends that each facility conduct periodic checks of each unit.**

1. Check the following at least daily:
  - Check that the unit is on a stable and level surface, e.g. on firm flooring, not on a thick carpet
  - Date and time settings
2. Visually inspect the following at least weekly:
  - Inspect the display for any damage or contamination
  - Inspect all cables, cords, and connector ends for damage or contamination
  - Inspect all safety-related labeling for legibility
  - Inspect all accessories (electrodes, etc.) for wear or damage
3. Visually inspect the following at least monthly:
  - Mounting screws (optional)

**Update settings, replace items, or call for service as necessary according to the results of the visual inspections. Do not use the unit if you see any signs of damage. Equipment that has been damaged must be checked for proper operation by qualified personnel before using again.**

**Do not wipe the equipment with corrosive chemicals (benzene, cleaner, etc.).**  
Please use a mild detergent to clean the equipment.

## Incorrect Ways to Measure

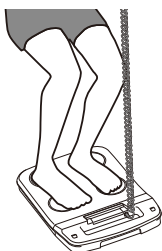

With bent knees



With bent elbows  
and wrists



With skin to skin contact

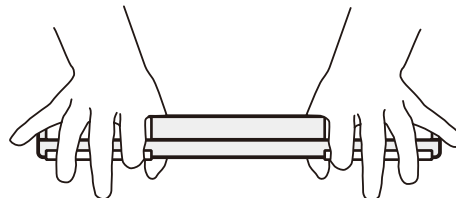

Without all fingers attached  
to the electrodes.

## Contact condition

- If your inner thighs are touching or your arms make skin-to-skin contact, the results can only be used as reference data.

# Part Names & Connection Procedure

en

Before use

## Front

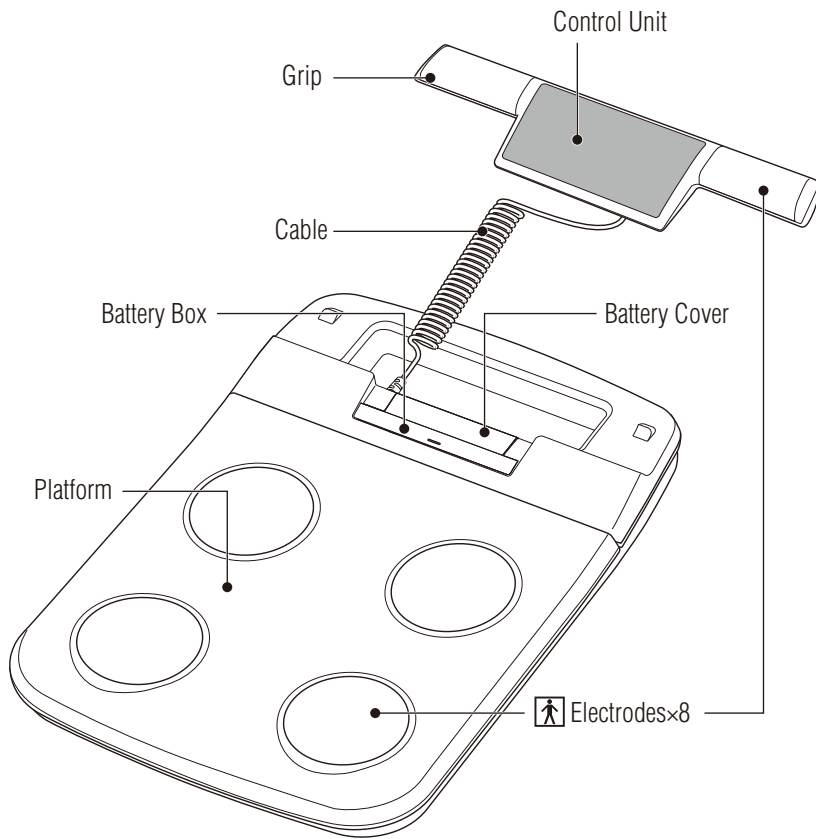

**Warning**  
Be careful not to tangle the cable.

The warning diagram shows two cable configurations. On the left, a cable is tangled and crossed out with a circle and a diagonal line. On the right, a cable is straight and has a checkmark next to it.

## Display Screen

Judgement Results  
Measurement results are judged based on five levels.

Displayed Item

Measurement Result

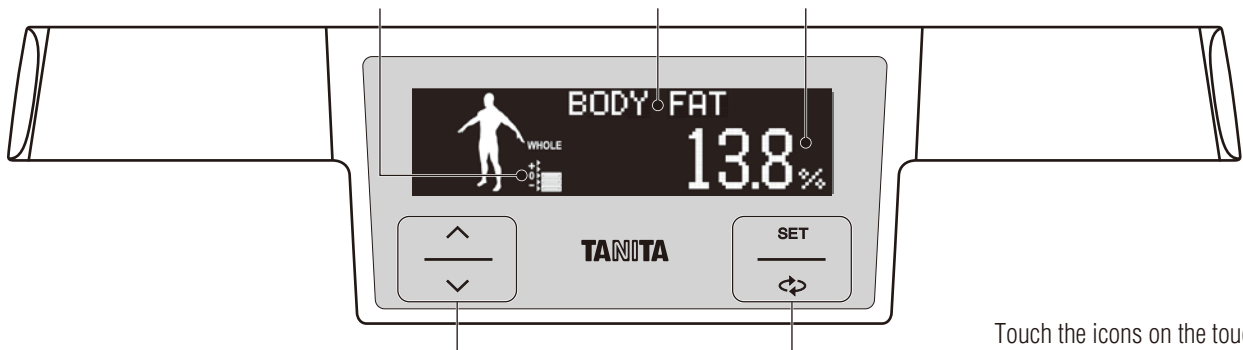

Touch the icons on the touch switch to operate.

UP button  
Count up

DOWN button  
Count down

SET SET button  
Enter

SELECT button  
Switch items



## Back

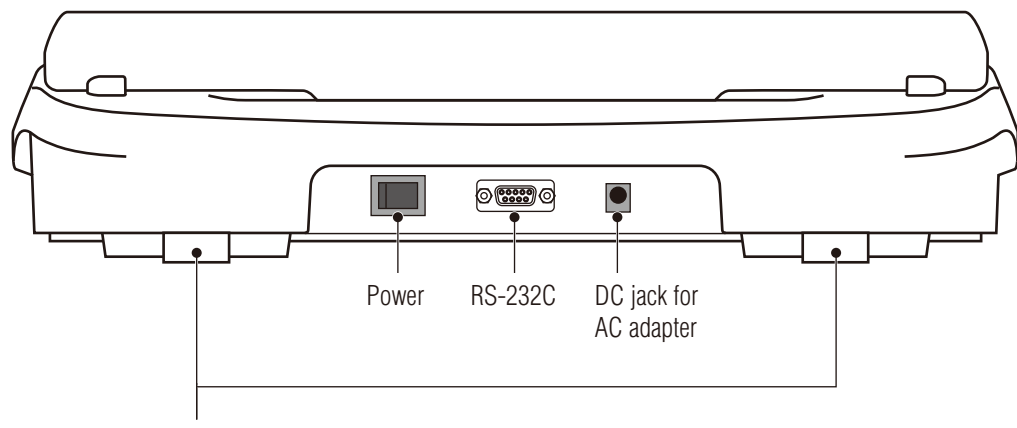

Adjustable feet × 2  
\*For further accuracy and security, please position the two adjustable feet on the base until they just make contact with the floor.

- Accessories**

  - Quick Start Guide
  - Location Code
  - AC adapter
  - AC plug

### Symbols and their Meanings

	WEEE- Waste Electrical and Electronic Equipment Directives		Serial number		Conformity with Medical Device Directive 93/42/EEC
	Caution Refer to the attached notes.		Manufacturer		See the instructions
	Polarity of DC power connector		Serial interface		Class II Equipment
	Direct current		For indoor use only		Input, Output
	Type BF applied part - Grips and platform		OFF (power)		ON (power)
	Alternating current		General prohibition sign		

# Power Supply

en

Before use

## Connecting to the Power Supply

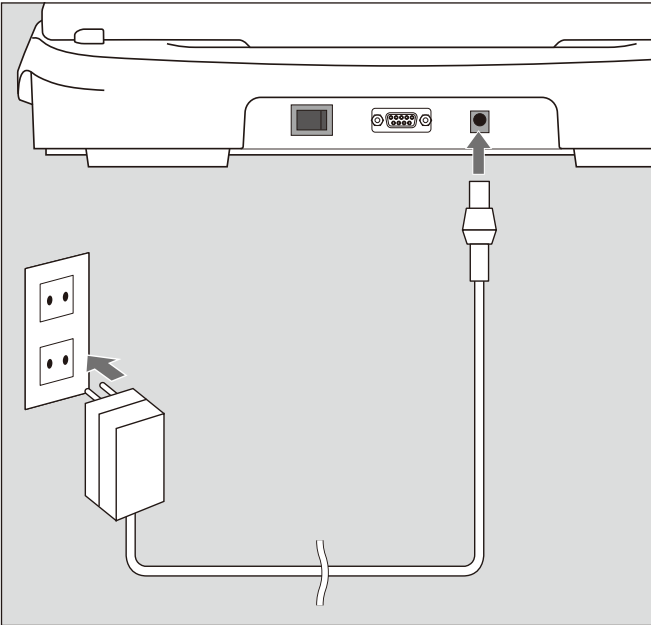

\*When using the AC adapter, please use it after removing the batteries.

## When Using Batteries

### Note

Batteries can also be used depending on the usage environment.

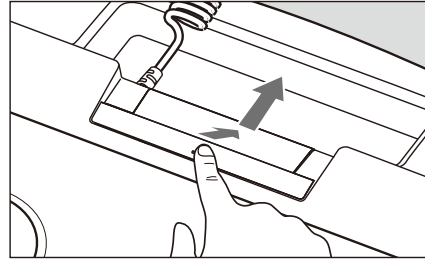

Press the point and then slide the battery cover to remove it.

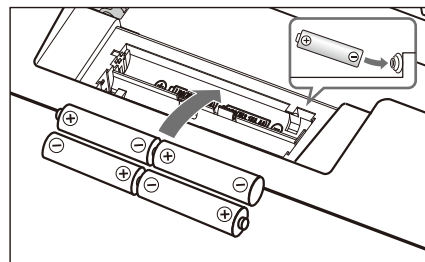

Insert batteries into the battery box.

If **LOW BATTERY** is displayed on the Display, please replace all four batteries (LR6 / AA) with new ones.

### Note

\*Uses 4 LR6 AA size alkaline batteries.

\*Battery life is approx. 12 hours of consecutive usage, but may differ depending on actual usage conditions.

\*Batteries are sold separately.

\*Unplug the AC adapter. Or the product won't work.

## Turning the Main Power ON/OFF

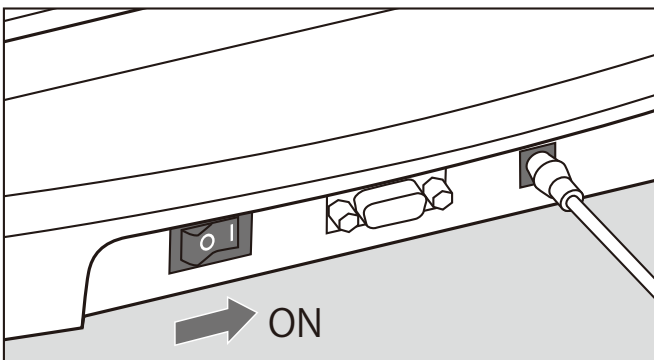

Press the Power Switch to turn the power on/off.

### Note

Once the power is turned on, version information is displayed.

## Emergency Shut Down

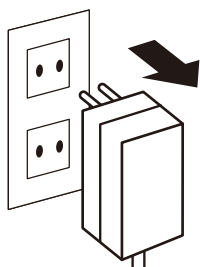

Keep the area around the plug socket clear during operation of the equipment in case of an emergency.

# Preparations before Use



en

Before use

## Set Your Location Code



When the power is first turned on with factory settings, the Location Code is displayed. Different locations across the world have varying gravitational pulls. This in turn affects the accuracy of weight readings on this product. By selecting the correct gravity setting according to your geographical location, you are guaranteed the most accurate weight readings.



1. Press the switch on the back to turn the power on. **AREA** is displayed in the Display Screen.
2. Refer to the map enclosed, and press the   buttons to select your location code.
3. Press the  button to enter and save the setting.

## Set the Date and Time



1. Select the year using the  and  buttons.
2. Press  to confirm.

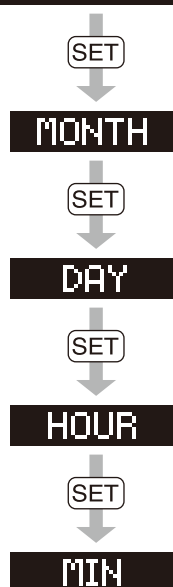



Set the date and time in the same way.  
**00** is displayed after displaying the set region, year, month, day and time.

# Preparations before Use

## Change Setting

Make sure that the main power supply of the product is on. (See P.10)

Press and hold the  button for 5 seconds or more to display the settings screen. Press   to choose the item you would like to set. (See P.22)

SETTINGS No.	Item	Default	Page
<b>SETTINGS 1</b> <b>PAIRING</b>	Pairing	—	13
<b>SETTINGS 2</b> <b>AREA</b>	Area	0 - 9	22
<b>SETTINGS 3</b> <b>DATE/TIME</b>	Date and Time	yyyy/mm/dd hh:mm	22-23
<b>SETTINGS 4</b> <b>CLOTHES-WT</b>	Clothes Weight	0 - 10.0kg/0.1kg 0 - 20.0lb/0.2lb	23
<b>SETTINGS 5</b> <b>BODY TYPE</b>	Body Type	On/Off(Standard only)	23
<b>SETTINGS 6</b> <b>LCD SLEEP</b>	LCD Sleep	Off/5/15/30 min	24
<b>SETTINGS 7</b> <b>RESTART</b>	Restart	Off/5/15/30 sec	24
<b>SETTINGS 8</b> <b>BUZZER</b>	Buzzer	On/Off	24
<b>SETTINGS 9</b> <b>OUT PUT</b>	Out put (and) Auto Print	Off/Printer/PC 0-2 sheet(s)	25
<b>SETTINGS 10</b> <b>PRINT-LANG</b>	Print Language	English/German/French/ Italian/Spanish/ Turkish/Polish/Japanese	25
<b>SETTINGS 11</b> <b>CONTROL MODE</b>	Control Mode	BLE/PC	25
<b>SETTINGS 12</b> <b>UNIT</b>	Units	kg cm/lb inch	26

# Taking Measurements

## Pairing

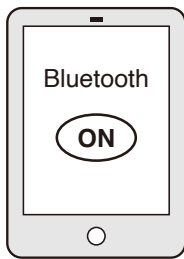

### Note

Make sure that the main power supply of the product is on before starting this operation.  
Up to three devices can be registered to this product.

Turn the *Bluetooth*® setting on, and download the app.

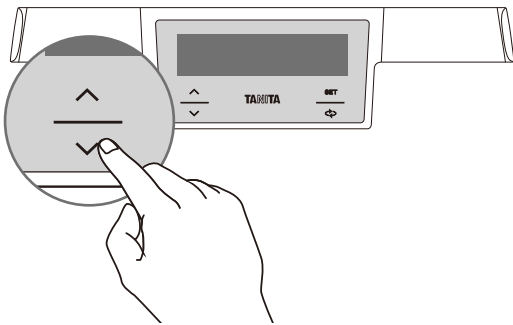

### Note

Do not place anything on the platform while pairing.

Press and hold the  button on the Control Unit for more than 5 seconds to switch to **SETTINGS 1 PAIRING**.

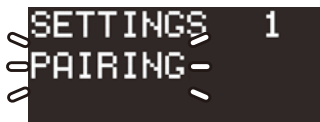

Press  button then **PAIRING connecting** is displayed.



Launch the app.  
Follow the instructions in the app and select MC-580.



The icon lights up on the display to indicate that a connection has been made.

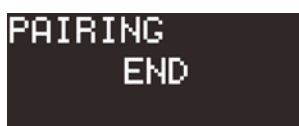

Pairing is complete when you hear the beeping sound.

### Note

The Error is displayed if pairing is not successful 60 seconds after starting the connection.

Press the  icon to return to the previous screen. Restart operations from the beginning, making sure to perform them correctly.



# Taking Measurements

en

How to use

1



## Note

Make sure that the main power supply of this product is on before starting this operation.

Stepping onto the platform wakes up the LCD when it is in SLEEP mode.

## Launch the App

Open the app on your mobile device.

2



## Start Measurements

Make sure that the Control Unit displays **0.0<sub>kg</sub>** then start measurements from the app.

## Note

The tare value and the word **NET** are displayed when CLOTHES-WEIGHT has been set. (See P.23)



3

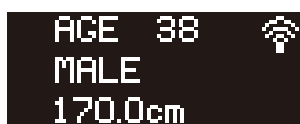

## Check

Registered personal information is sent and displayed on the Control Unit.

## Note

The  mark is displayed when the Athletic mode is selected.

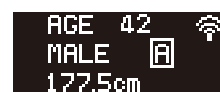

## Athletic Mode

Recommended for those who are 18 years or older and meet the following conditions.

- People who carry out 12 hours or more of cardiovascular exercise a week.
- People who belong to a sport team or a sport organization with the aim of participation in competition, etc.
- People who are professional athletes.

4



### Measure Body Weight

Make sure the Control Unit reads 0.0<sub>kg</sub> then step barefoot onto the platform.

**Note**

Measurement results are not output to the app, printer or PC.

Your weight is displayed when you hear the beeping sound.

**Note**

Do not grip the Control Unit until weight measurements are finished.

**RELEASE GRIP**

**RELEASE GRIP** is displayed when the Control Unit is held during weight measurements.

5



40sec ..... 10sec → 5sec

### Measuring Body Composition

When **HOLD GRIP** is displayed, hold the grip with both hands, ensure that your arms are fully extended and your elbows do not touch your body.

The impedance measurements are completed when you hear the continual beeping sound. Measurement results are displayed.

**Note**

To ensure accuracy, readings should be taken without clothing and under consistent conditions of hydration. Always remove your socks or stockings, and be sure the soles of your feet are clean before stepping on the platform. Be sure that the arch of each foot is aligned with the center of the platform. Don't worry if your feet appear too large for the platform, accurate readings can still be obtained if your toes overhang the platform. It is best to take readings at the same time of day. Try to wait about three hours after getting up, eating, or strenuous exercise before taking measurements. While readings taken under other conditions may not have the same absolute values, they are accurate for determining the percentage change as long as the readings are taken in a consistent manner. To monitor your progress, compare your weight and body fat percentage readings taken under the same conditions over a period of time.

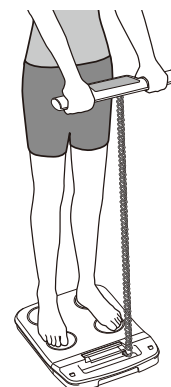
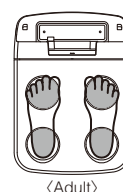
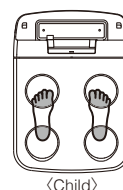

# Taking Measurements

en

How to use

## 6

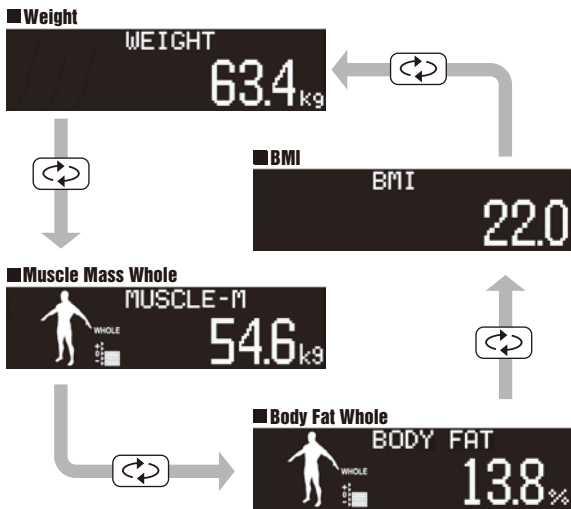

## Measurement Results

The displayed items can be switched by pressing while measurement results are being displayed.

Press to display the measurement results for individual parts (balance of individual parts, left arm, right arm, left leg, right leg, trunk). (See P. 20)

The measurement results are displayed after measurement is completed and simultaneously output to the app.

### Note

If you select "PRINT" or "PC" in the output settings, measurement results are automatically sent to the printer/PC. (see P.25)

## 7

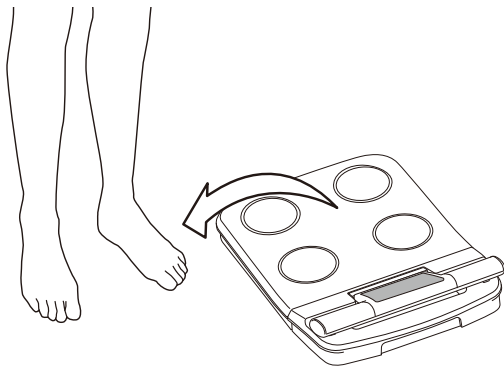

## Quit Measurement

Return the Control Unit to its original position after reviewing your measurement results and step off the platform.

The product automatically turns off.

### Note

If you set "RESTART", the next screen is displayed automatically when you step off the platform.

### Note

To quit immediately, press the button to display the end screen.

Select **YES** with the buttons and press to confirm.

Do not quit while the is lit up because this indicates that measurement results are still being sent.



### Note

If your inner thighs are touching or your arms make skin-to-skin contact, the displayed results can only be used as reference data. Reference data is indicated by a \* mark.

Please check the measuring posture. (see P.7)

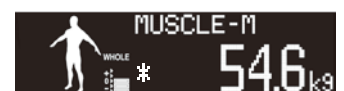
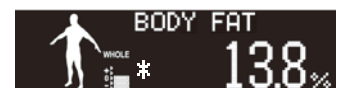

### Note

**Error** is displayed if the body fat percentage is outside the measurement range.



# Taking Measurements without Registering

This method is most convenient for one-time users as personal data and measurement results are not stored.

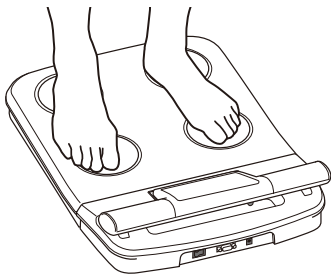

**Note**

Make sure that the main power supply of this product is on before starting this operation. Stepping onto the platform wakes up the LCD when it is in SLEEP mode.

## Measuring Body Weight

Make sure the Control Unit reads **0.0<sub>kg</sub>** then step barefoot onto the platform.

**Note**

Measurement results are not output to the printer or PC.

**Note**

Press the **SET** button to perform a reset. The tare value and the word **NET** are displayed when CLOTHES-WEIGHT has been set.



Your weight is displayed when you hear the beeping sound.

**Note**

Do not grip the Control Unit until weight measurements are finished.



**RELEASE GRIP** is displayed when the Control Unit is held during weight measurements.

**Note**

To ensure accuracy, readings should be taken without clothing and under consistent conditions of hydration. Always remove your socks or stockings, and be sure the soles of your feet are clean before stepping on the platform. Be sure that the arch of each foot is aligned with the center of the platform. Don't worry if your feet appear too large for the platform, accurate readings can still be obtained if your toes overhang the platform. It is best to take readings at the same time of day. Try to wait about three hours after getting up, eating, or strenuous exercise before taking measurements. While readings taken under other conditions may not have the same absolute values, they are accurate for determining the percentage change as long as the readings are taken in a consistent manner. To monitor your progress, compare your weight and body fat percentage readings taken under the same conditions over a period of time.

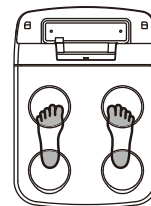

<Child>

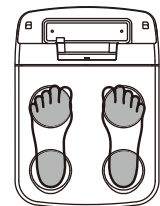

<Adult>

# Taking Measurements without Registering

en

How to use

## 2

INPUT  
PERSONAL DATA

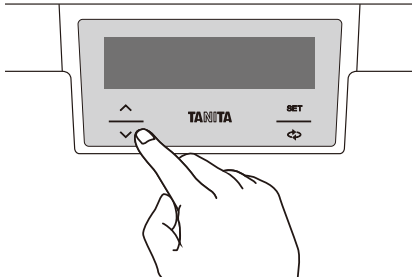

BODY TYPE  
- STANDARD -



GENDER



AGE



HEIGHT

### Enter Personal Data

Set personal data by selecting it with the buttons and setting it by pressing the button.

#### Note

Indicates whether "Standard mode or Athletic mode" is selected as the body type.

#### Athletic Mode

Recommended for those who are 18 years or older and meet the following conditions.

- People who carry out 12 hours or more of cardiovascular exercise a week.
- People who belong to a sport team or a sport organization with the aim of participation in competition, etc.
- People who are professional athletes.

## 3

HOLD GRIP  
ARMS STRAIGHT

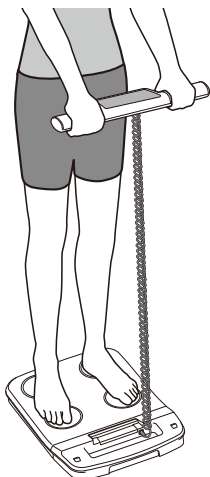

### Measuring Body Composition

Setting is complete when **HOLD GRIP** is displayed. Hold the Grip in both hands.



40sec ..... 10sec → 5sec

The impedance measurements are completed when you hear the continual beeping sound. Measurement results are displayed.

# 4

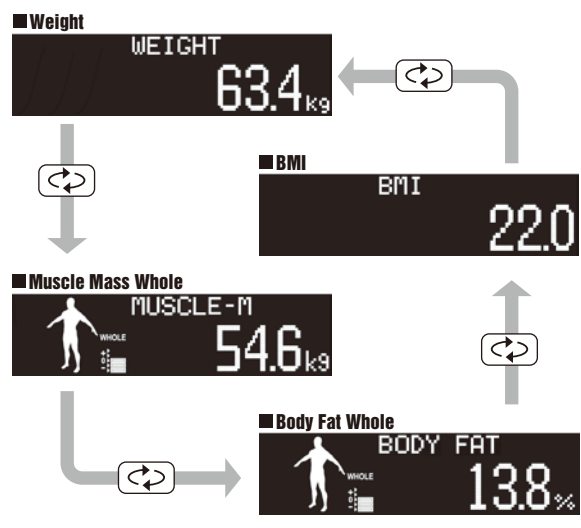

## Measurement Results

The displayed items can be switched by pressing while measurement results are being displayed.

Press to display the measurement results for individual parts (balance of individual parts, left arm, right arm, left leg, right leg, trunk). (See P.20)

### Note

If you select "PRINT" or "PC" in the output settings, measurement results are automatically sent to the printer/PC. (see P.25)

# 5

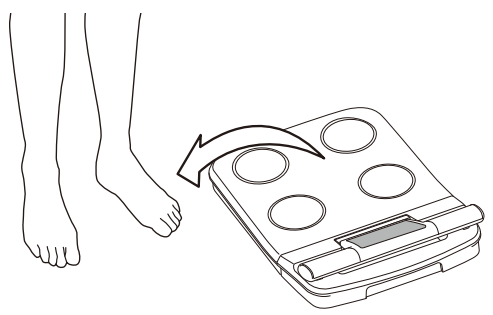

## Quit Measurement

Return the Control Unit to its original position after reviewing your measurement results and step off the platform. The product automatically turns off.

### Note

If you set "RESTART", the next screen is displayed automatically when you step off the platform.

### Note

To quit immediately, press the **SET** button to display the end screen. Select **YES** with the buttons and press **SET** to confirm. Do not quit while the connection icon is lit up because this indicates that measurement results are still being sent.



### Note

If your inner thighs are touching or your arms make skin-to-skin contact, the displayed results can only be used as reference data. Reference data is indicated by a \* mark. Please check the measuring posture. (see P.7)

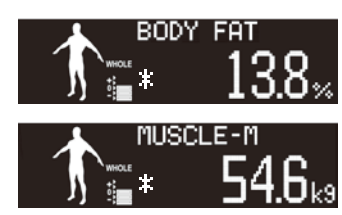

### Note

**Error** is displayed if the body fat percentage is outside the measurement range.



# Measurement Results

en

How to use

# 1

## Measurement Results by Part

The displayed items can be switched by pressing  while measurement results are being displayed. Press   to display the measurement results for individual parts (balance of individual parts, left arm, right arm, left leg, right leg, trunk).

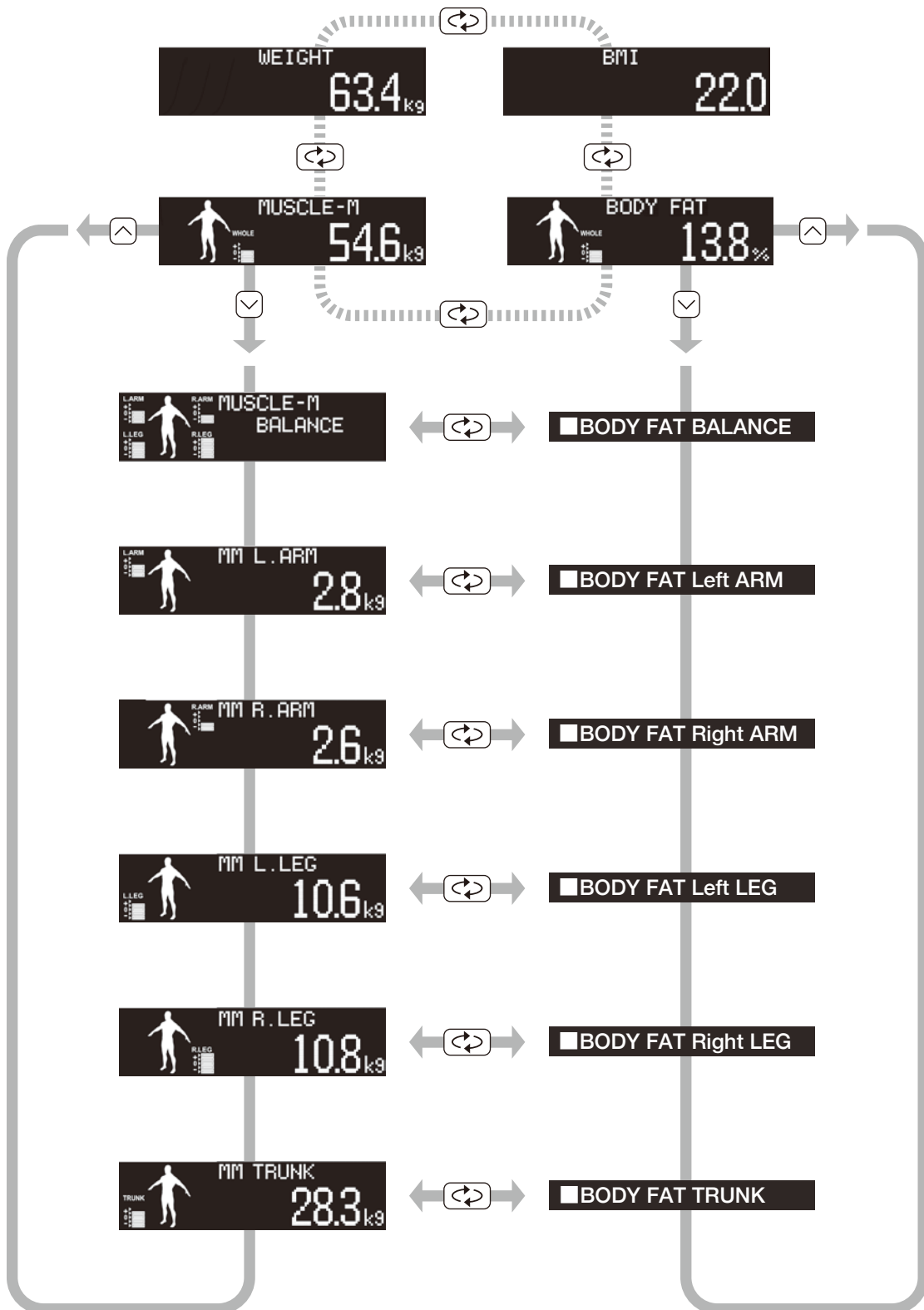

# 2 Judgment Results

Review ratings for fat percentage and muscle mass for the whole body and by part.

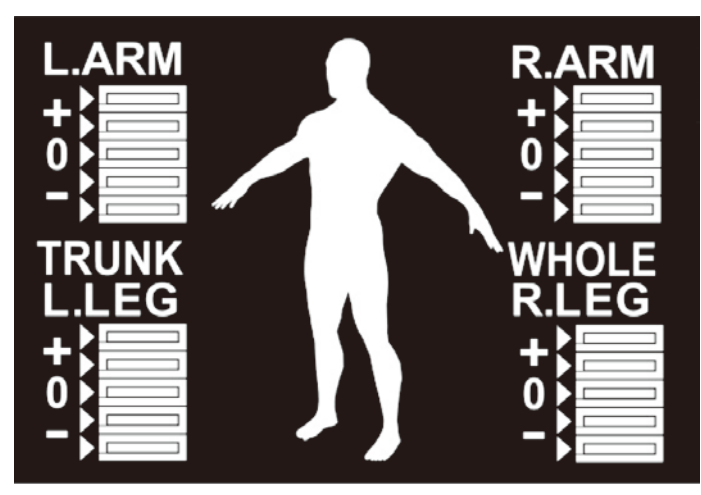

	--	-	0	+	++
Total Body Fat Ratio Rating	Underfat	-Healthy	+Healthy	Overfat	Obese
Body Fat Ratio Rating by Part	Underfat	-Healthy	+Healthy	Overfat	Obese
Total Muscle Mass Rating	Low	-Average	Average	+Average	High
Muscle Mass Rating by Part	Low	-Average	Average	+Average	High

### Healthy Range Indicator

Your Body Composition Analyzer automatically compares your body fat percentage reading to the Healthy Body Fat Range chart.

- Underfat: Below the healthy body fat range. Increased risk of health problems.
- Healthy/+Healthy: Within the healthy body fat percentage range for your age/ gender.
- Overfat: Above the healthy range. Increased risk of health problems.
- Obese: Far above the healthy body fat range. Greatly increased risk of obesity-related health problems.

### Muscle Mass Score (age 18-99)

This function indicates the weight of muscle in your body. The muscle mass displayed includes skeletal muscle, smooth muscle (such as cardiac and digestive muscle) and the water contained in these muscles. Muscles play an important role as they act as an engine that consumes energy. As your muscle mass increases, your energy consumption increases helping you reduce excess body fat levels and lose weight in a healthy way.

The muscle mass is judged for persons aged 18 and over. Muscle mass is judged by calculating the amount of muscle mass against the person's height, and then the amount is classified. The app that links with this device displays the muscle mass judgement as a muscle score, as shown below. The larger the number, the more muscle the person has.

Low	Average			High
-2	-1	0	+1	+2

# Settings

en

How to use

Press and hold the  button for 5 seconds or more to begin from the start screen. Select the item to be set with the   buttons once the settings screen is displayed. Press the  button to return to the measurement screen.





















## Note

Do not place anything on the platform while setting.

## Set Your Location Code

Press the  button when **SETTINGS 2 AREA** is displayed.

Select the area using the   buttons then press the  button. The product beeps to indicate this is completed.

## Note

Check the included Location Codes for the usage area.

## Setting the Date and Time

Press the  button when **SETTINGS 3 DATE/TIME** is displayed.

Select the year using the   buttons then press the  button.

Select the month using the   buttons then press the  button. The product beeps to indicate this is completed.

Select the day using the   buttons then press the  button. The product beeps to indicate this is completed and the time settings are displayed.



Select the hour using the  $\downarrow$   $\uparrow$  buttons then press the **SET** button. The product beeps to indicate this is completed.

Select the minutes using the  $\downarrow$   $\uparrow$  buttons then press the **SET** button. The product beeps to indicate this is completed.

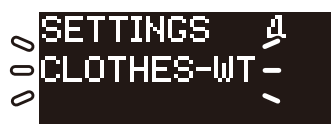

## CLOTHES-WEIGHT

Enter the preset tare value (clothes weight)  
The tare value range is 0.0 to 10.0kg / 0 to 20.0lb

Press the **SET** button when **SETTINGS 4 CLOTHES-WT** is displayed.

Select the clothes weight using the  $\downarrow$   $\uparrow$  buttons then press the **SET** button. The product beeps to indicate this is completed.

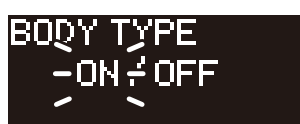

## BODY TYPE

Press the **SET** button when **SETTINGS 5 BODY TYPE** is displayed.

Select using the  $\downarrow$   $\uparrow$  buttons then press the **SET** button.

If the body type selection (Athletic mode) is set to **OFF**, the display switches directly to "Select gender" without requesting a body type.

The product beeps to indicate this is completed.

### Note

#### Athletic Mode

•Recommended for those who are 18 years or older and meet the following conditions.

- People who carry out 12 hours or more of cardiovascular exercise a week.
- People who belong to a sport organization with the aim of participation in competition, etc.
- People who are professional athletes.

# Settings

en

How to use



SETTINGS 6  
LCD SLEEP

SET



LCD SLEEP  
OFF

## Setting LCD Auto-Sleep

Set the amount of time to elapse before the LCD turns off and whether LCD SLEEP mode is enabled or disabled.

Press the **SET** button when **SETTINGS 6 LCD SLEEP** is displayed.

Select the time before entering SLEEP mode using the **↓** **↑** buttons then press the **SET** button.



The product beeps to indicate this is completed.



SETTINGS 7  
RESTART

SET

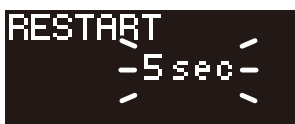

RESTART  
5 sec

## RESTART

Set the time before automatically starting the next measurement after stepping off the platform.

Press the **SET** button when **SETTINGS 7 RESTART** is displayed.

Select the time using the **↓** **↑** buttons then press the **SET** button.



The product beeps to indicate this is completed.



SETTINGS 8  
BUZZER

SET

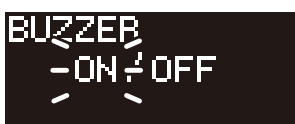

BUZZER  
ON/OFF

## Setting the Buzzer

Press the **SET** button when **SETTINGS 8 BUZZER** is displayed.

Use the **↓** **↑** buttons to turn the buzzer on or off then press the **SET** button.

The product beeps to indicate this is completed.



```

00 SETTINGS 9
00 OUT PUT -
  
```

SET

```

00 OUT PUT
00 OFF/PRINT/PC
  
```

SET

```

AUTO PRINT
-0/1/2
  
```

```

00 SETTINGS 10
00 PRINT-LANG -
  
```

SET

```

PRINT-LANG
-ENGLISH-
  
```

## Setting Output

Connect this product using an RS-232C cable to print or output measurement results to a PC.

Press the **SET** button when **SETTINGS 9 OUT PUT** is displayed.

Use the **▽** **△** buttons to enable or disable printer or PC output then press the **SET** button.

The product beeps then proceeds to auto print settings.

### Note

If you select "PRINT" or "PC" in the output settings, measurement results are automatically sent to the printer/PC.

Set to enable or disable printing as well as manual or automatic printing. Select the number of pages to auto print using the **▽** **△** buttons then press the **SET** button. Set to manual printing by selecting **0**.

The product beeps to indicate this is completed.

### Note

Press and hold **SET** button for more than 3 seconds while measurement results are displayed to display a print sheet and print manually.

## Setting Print Language

Set the language for printing.

Press the **SET** button when **SETTINGS 10 PRINT-LANG** is displayed.

Use the **▽** **△** buttons to scroll through a list of supported languages. Press the **SET** button to set the language displayed.

The product beeps to indicate this is completed.

### Note

The following languages are supported for this product.  
English/German/French/Italian/Spanish/Turkish/Polish/Japanese

# Settings

en

How to use



## Setting Control Mode

Select "PC" in "Control Mode" to send registered personal information from your PC when taking measurements.

Press the **(SET)** button when **SETTINGS 11 CONTROL MODE** is displayed.

Select using the **(V)** **(^)** buttons then press the **(SET)** button. The product beeps to indicate this is completed.

### Note

If you select "PC" in "Control Mode", measurements results are output to your PC even if you select "OFF" in "Output".

If you select "PC" in "Control Mode", the icon lights up on the display.



## Setting Units

The units used on this product can be set between **lb in** and **kg cm**.

Press the **(SET)** button when **SETTINGS 12 UNIT** is displayed.

Select using the **(V)** **(^)** buttons then press the **(SET)** button. The product beeps to indicate this is completed.



## End Settings

Press the **(SET)** button when **SETTINGS END** is displayed to return to the measurement screen.

# Troubleshooting

If you are experiencing problems, please check the following before asking for repairs.

Problem		Solution
Measuring	Impedance measurement Error	<ul style="list-style-type: none"> <li>• Hold the handgrips and electrodes firmly with fingers and palms.</li> <li>• Stand barefoot on the platform when measuring.</li> <li>• If the soles of the feet are dry, use a dropper to apply about 0.5 mL of water onto the platform before measurement.</li> <li>• Reconfirm the input details.</li> </ul>
	Zeroing Error	<ul style="list-style-type: none"> <li>• Turn off the power, remove everything from the platform, then turn on the power and try measuring again.</li> </ul>
	Weight value does not stabilize.	<ul style="list-style-type: none"> <li>• Is this product set up on a surface that is vibrating or near something that is vibrating?</li> <li>• Is the platform tilted?</li> <li>• Is something blocking the gaps in the platform?</li> <li>• Remove any inserted objects.</li> </ul>
Displayed LCD	Nothing is displayed even when the power is turned on.	<ul style="list-style-type: none"> <li>• Confirm that the power is connected correctly.</li> </ul>
	"OVERLOAD" is displayed.	<ul style="list-style-type: none"> <li>• The weight to be measured exceeds the maximum capacity.</li> </ul>
	* is displayed	<ul style="list-style-type: none"> <li>• The measuring posture is incorrect. The results can only be used as reference data. See P.7 Incorrect Ways to Measure, Contact Condition.</li> </ul>

# Specifications

en

If necessary

Model number		MC-580M
Classification		MDD: Class IIa
Power source	AC adapter (Class II)	CONTINUOUS OPERATION Input: 100-240V AC 50-60Hz 0.32-0.19A Output: 9V DC 1.2A
	Battery	6V DC LR6 (AA alkaline battery) ×4 (Not included)
Electric current range		25VA
Impedance measurement	Measurement system	Dual-frequency 8 electrode
	Measurement frequency	6.25kHz, 50kHz
	Measurement current	90μA or less
	Electrode materials	Stainless steel
	Measurement part	Whole body/Right arm/Left arm/Right leg/Left leg/Trunk
	Measurement range	200 to 900Ω (0.1Ω increments)
	Accuracy at first calibration	±2%
Weight measurement	Measurement system	Strain gauge load cell
	Maximum capacity	270kg/600lb (including preset tare value)
	Minimum graduation	0.1kg/0.2lb
	Accuracy at first calibration	±0.2kg/±0.4lb
Display		LCD screen
Interface		RS-232C
Usage conditions range	Temperature	5 to 35°C/41 to 95°F
	Relative humidity	30 to 80% (without condensation)
	Maximum altitude	2,000m ASL/6500ft ASL
	Atmospheric pressure	86 to 106kPa
Storage/ Transport conditions range	Temperature	-10 to 60°C/14 to 140°F
	Relative humidity	10 to 90% (without condensation)
	Atmospheric pressure	70 to 106kPa
Product weight, Product size	Control unit	367×34×89mm, 0.3kg/14.4×1.3×3.5in, 0.7lb
	Platform	394×75×551mm, 7.4kg/16×3×22in, 16lb
Time accuracy		Within ±1 minute per month (normal temperature)
Wireless device specification	Radio equipment type	Bluetooth® 4.0
	Frequency band	2402 to 2480MHz
	Maximum RF output power (adaptive frequency)	8.488dBm (2480MHz)

Input items	Gender	Female/Male
	Body type	Standard/Athletic* <sup>1</sup>
	Age	5 to 99 years
	Height	90.0 to 249.9cm (0.1cm increments)/ 3'0.0" to 7'11.5" (0.5inch increments)
	Clothes weight	0.0 to 10.0kg (0.1kg increments) 0.0 to 20.0lb (0.2lb increments)
Output items	Total & Segmental Muscle Mass	0.1kg/0.2lb increments
	Total & Segmental Body Fat %	0.1% increments
	Muscle Mass Balance* <sup>2</sup>	
	Body Fat Balance	
	BMI (Body Mass Index)	0.1 increments

The following items can be output when the product is connected to a dedicated thermal printer.

Print items (Thermal Printer/ Results Sheet)	Overview	Gender	Female/Male
		Body Type	Standard/Athletic* <sup>1</sup>
		Age	5 to 99 years
		Height	90.0 to 249.9cm (0.1cm increments)/ 3'0.0" to 7'11.5" (0.5inch increments)
		Weight	2.0 to 270.0kg (0.1kg increments)/ 4.4 to 600.0lb (0.2lb increments)
		Fat%	3.0 to 75.0% (0.1% increments)
		Fat Graph	
		FFM(Fat Free Mass)	(0.1kg/0.2lb increments)
		Muscle Mass	(0.1kg/0.2lb increments)
		Muscle Mass Graph* <sup>2</sup>	
		TBW	(0.1kg/0.2lb increments)
		Bone Mass	(0.1kg/0.2lb increments)
		BMR (Basal Metabolic Rate)	(1kcal/1kJ increments)
		BMR (Basal Metabolic Rate) Graph* <sup>2</sup>	
		Visceral Fat Rating* <sup>2</sup>	1 to 59 (1 increments)
		Visceral Fat Graph* <sup>2</sup>	
		Metabolic Age* <sup>2</sup>	(1 year increments)
		Leg Muscle Score* <sup>2</sup>	50 to 150 (1pt increments)
	Leg Muscle Score Graph* <sup>2</sup>		
	BMI (Body Mass Index)	(0.1 increments)	
	BMI Graph* <sup>2</sup>		
Physique Rating* <sup>2</sup>			
Segmental	Fat%	1.0 to 75.0% (0.1% increments)	
	Muscle Mass	(0.1kg/0.2lb increments)	
Others	Bioelectrical data ( $\Omega$ )	Reactance, Resistance	

\*1 Athletic mode can only be selected between 18-99 years old.

\*2 18 to 99 years.

# Specifications

en

The following data can be output using a supported app.

If necessary

Applicable items	Overview	ID	
		Date	
		Time	
		Body Type	Standard/Athletic* <sup>1</sup>
		Gender	Female/Male
		Age	5 to 99 years
		Height	90.0 to 249.9cm (0.1cm increments)/ 3'0.0" to 7'11.5" (0.5inch increments)
		Clothes Weight	0.0 to 10.0kg (0.1kg increments) 0.0 to 20.0lb (0.2lb increments)
		Weight	2.0 to 270.0kg (0.1kg increments)/ 4.4 to 600.0lb (0.2lb increments)
		Fat%	3.0 to 75.0% (0.1% increments)
		Fat % Rating	
		Fat Mass	(0.1kg/0.2lb increments)
		FFM (Fat Free Mass)	(0.1kg/0.2lb increments)
		Muscle Mass	(0.1kg/0.2lb increments)
		Muscle Mass Rating* <sup>2</sup>	
		Bone Mass	(0.1kg/0.2lb increments)
		TBW	(0.1kg/0.2lb increments)
		TBW%	(0.1% increments)
		BMI (Body Mass Index)	(0.1 increments)
		Ideal Body Weight* <sup>2</sup>	(0.1kg/0.2lb increments)
		Degree of Obesity	(0.1% increments)
		Ideal Body Fat	(0.1% increments)
		Ideal Body Muscle Mass* <sup>2</sup>	(0.1kg/0.2lb increments)
		Visceral Fat Rating* <sup>2</sup>	1 to 59 (1 increments)
	BMR (Basal Metabolic Rate)	(1kcal/1kJ increments)	
	Metabolic Age* <sup>2</sup>	(1 year increments)	
	Physique Rating* <sup>2</sup>		
	Muscle Mass Balance* <sup>2</sup>		
	Balance (Both Arms)* <sup>2</sup>		
	Balance (Both Feet)* <sup>2</sup>		
	Protein (estimated)* <sup>2</sup>	(0.1kg/0.2lb increments)	
	Segmental	Fat%	1.0 to 75.0% (0.1% increments)
		Fat Mass	(0.1kg/0.2lb increments)
		FFM (Fat Free Mass)	(0.1kg/0.2lb increments)
		Muscle Mass	(0.1kg/0.2lb increments)
		Fat% Rating	
Muscle Mass Rating* <sup>2</sup>			
Others	MM/H2	Whole body Muscle Mass (kg)/Height (m) <sup>2</sup>	
	MM/BW	Whole body Muscle Mass (kg)/Body Weight (kg)	
	SMI (Skeletal Muscle Mass Index)	Total muscle mass value of Right arm, Left arm, Right leg and Left leg (kg)/Height (m) <sup>2</sup>	
	ASM*/ BW *Appendicular Skeletal Muscle Mass	Total muscle mass value of Right arm, Left arm, Right leg and Left leg (kg)/Body Weight (kg)	
	Bioelectrical data (Ω)	Reactance, Resistance	
Contact condition* <sup>3</sup>			

\*1 Athletic mode can only be selected between 18 to 99 years old. \*2 18 to 99 years

\*3 The results can only be used as reference data. (See P.7) For contact condition, please refer to instructions for "Data Output Format". The product design and specifications may be changed at any time without prior notice.

## Note

See the handling instructions, homepage or other instructions made by the company of the app for information on operations.

Connect this product using an RS-232 cable to transmit measurement results to a PC.

See the MC-580 Serial Output Specifications for further information.



This product meets the following requirements;  
1. Medical Device Directive (93/42/EEC)  
2. RoHS Directive (2011/65/EU)

Hereby, TANITA declares that the radio equipment type [MC-580M] is in compliance with Directives: 2014/53/EU

The full text of the EU declaration of conformity is available at the following internet address: <https://tanita.eu/help-guides/products-manuals/>

Target country list (ISO3166-1 2 Letter Code)

AT BE BG CY CZ DK EE FI FR DE GR HU IE IT LV LT LU MT  
NL PL PT RO SK SI ES SE GB HR

- The *Bluetooth*® word mark and logos are registered trademarks owned by the Bluetooth SIG, Inc. and any use of such marks by TANITA Corporation is under license. Other trademarks and trade names are those of their respective owners.

#### Disposal



This is an electronic device.  
Please dispose of it as an electronic device, not as general household waste. Please follow the regulations in your local region when disposing of this device.



#### ⚠ Not allowed to mix batteries with consumer wastes!

As consumer you are legally bound to return used or discharged batteries. You can deposit your old batteries at the public collecting points in your town, or wherever the corresponding batteries are sold and specifically marked collecting boxes have been set up. In case of scrapping the apparatus, the batteries should be removed from it and deposited at the collecting points as well.

#### <Manufacturer> TANITA Corporation

1-14-2 Maeno-cho, Itabashi-ku, Tokyo  
174-8630 Japan  
TEL: +81-(0)3-3968-7048  
FAX: +81-(0)3-3968-2661  
[www.tanita.co.jp](http://www.tanita.co.jp)

#### <EU Representative> TANITA Europe B.V.

Hoogoorddreef 56-E, 1101 BE Amsterdam,  
the Netherlands  
TEL: +31-(0)20-560-2970  
FAX: +31-(0)20-560-2988  
[www.tanita.eu](http://www.tanita.eu)

#### TANITA Corporation of America, Inc.

2625 South Clearbrook Drive,  
Arlington Heights, IL 60005 USA  
TEL: +1-847-640-9241  
FAX: +1-847-640-9261  
[www.tanita.com](http://www.tanita.com)

#### TANITA Health Equipment H.K. Ltd.

Unit 301-303, 3/F Wing On Plaza,  
62 Mody Road, Tsimshatsui East, Kowloon,  
Hong Kong  
TEL: +852-2834-3917  
FAX: +852-2838-8667  
[www.tanita.asia](http://www.tanita.asia)

#### TANITA (Shanghai) Trading Co., Ltd.

Room 8005, 877 Huai Hai Zhong Lu,  
Shanghai, The People's Republic of China  
TEL: +86-21-6474-6803  
FAX: +86-21-6474-7901  
[www.tanita.com.cn](http://www.tanita.com.cn)