

## Instruction Manual

### BODY COMPOSITION ANALYZER

# DC-13C

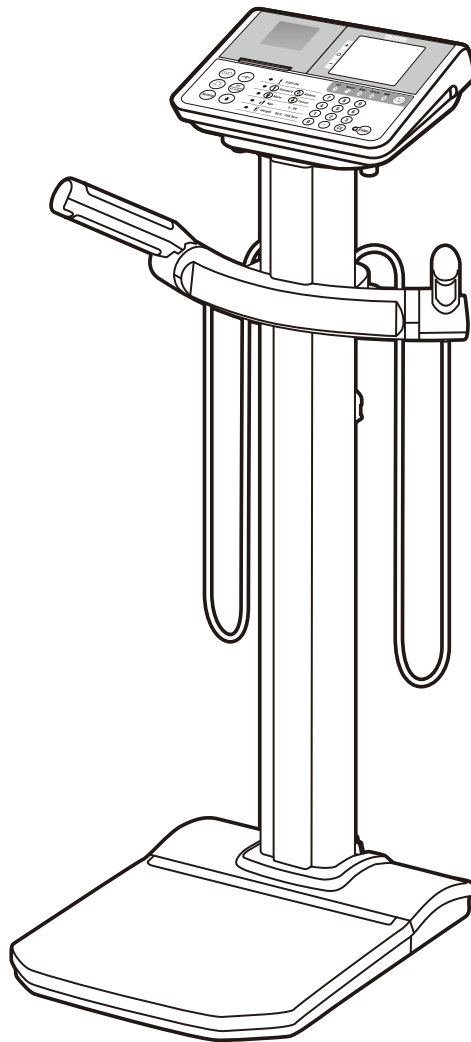

#### <Usage Conditions>

Temperature Range : 5 – 35°C  
Relative Humidity Range : 30 – 80% (non-condensing)  
Max Altitude : 2,000m ASL/6500ft ASL  
Atmospheric Pressure Range: 86 – 106kPa

#### <Storage Conditions>

Temperature Range : -10 – 60°C  
Relative Humidity Range : 10 – 90% (non-condensing)  
Atmospheric Pressure Range : 70 – 106kPa

To avoid malfunctions, avoid storing the equipment in a place with direct sunlight, significant temperature changes, a risk of dampness, a large amount of dust or a risk of vibration or impact, or in the vicinity of flames.



Please read this Instruction Manual carefully and keep it for future reference.

# Contents

en

## Before Use

<b>For Your Safety</b> .....	<b>3</b>
<b>Checking the Contained Items</b> .....	<b>7</b>
<b>Positioning the Scale/Setting up the Mat</b> .....	<b>8</b>
<b>Part Names &amp; Connection Procedure</b> .....	<b>9</b>
<b>Setting the Printer Paper</b> .....	<b>12</b>
<b>Setting an SD Card</b> .....	<b>13</b>
<b>Power Supply</b> .....	<b>14</b>
<b>Settings</b> .....	<b>15</b>

## How to Use





<b>Taking a Measurement</b> .....	<b>17</b>
Body Composition Mode .....	17
Measurement Results .....	19
Scale Mode .....	21
<b>Output and Storage of Measurement Results</b> .....	<b>22</b>
General Instructions for Body Composition Measurement.....	22
Select Printing Data .....	23
Printing Data .....	23
Lists of Contents of the Print Item Preset .....	24
In the Case to Select the Print Item Preset .....	25
Reading Stored Measurement Result Data .....	26
Data Output.....	27
Data Storage .....	27

## If Necessary





<b>Troubleshooting</b> .....	<b>28</b>
<b>Specifications</b> .....	<b>29</b>

# For Your Safety

This section explains precautionary measures to be taken to avoid injury to the users of this equipment and others, and to prevent damage to property. Please familiarise yourself with this information to ensure safe operation of this equipment.

 <b>Warning</b>	Failure to follow instructions highlighted with this mark could result in death or severe injury.
 <b>Caution</b>	Failure to follow instructions highlighted with this mark could result in injury or damage to property.
 Prohibited	This mark indicates actions that are prohibited.
 Required	This mark indicates instructions that must always be followed.

## Warning

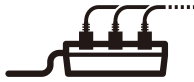
 Prohibited	<p><b>This equipment must not be used on subjects with pacemakers or other mechanical implants.</b></p> <p>This equipment passes a weak electrical current through the body which could interfere with and cause the malfunction of electrical medical implants, with serious consequences.</p>	
	<p><b>Do not handle the plug with wet hands.</b></p> <p>This may result in electric shock, fire, or current leakage.</p>	
	<p><b>Do not modify this equipment.</b></p> <p>There is a risk of electrocution or injury, and precise analysis cannot be guaranteed.</p>	
	<p><b>Do not use multiple adapters.</b></p> <p>This may result in fire.</p>	
	<p><b>Do not use the equipment if you have any kind of wound or inflammation on any part of your body that comes into direct contact with the equipment.</b></p>	

# For Your Safety (continued)

en

Before Use

## Caution



Prohibited

**Do not allow the equipment to get wet.**

**Avoid using on subjects with allergies to metals.**

Allergic reactions may be caused by the stainless steel used in the electrodes of this equipment.

**Do not jump on the equipment.**

**Do not tilt the equipment.**

**Do not use this equipment near other products that emit electromagnetic waves.**

**Do not insert fingers into any of the gaps or holes.**

**Do not apply force to the display.**

The screen may break and cause injury.

**Do not place items sensitive to magnetic forces near the equipment.**

The magnet of the impedance meter may corrupt data on devices such as USB memory sticks if these are placed near the equipment.

**Assist persons with disabilities.**

Another person should assist persons with disabilities who may not be able to take a measurement alone.



Required

**Clean the equipment after each use.**

Wipe off the equipment if dust accumulates or it becomes dirty.

**Stand clear of the subject during measurement to ensure accuracy.**

**Continually monitor both the subject and the equipment for anomalies.**

If an anomaly in the subject or equipment is discovered, take appropriate action, such as stopping the equipment, while ensuring the safety of the subject.

**Use the included AC cable.**

**Do not lean against the equipment.**

**Unplug the AC cable from the equipment when moving it.**

**Interpretation of analysis results (e.g. evaluation of measurements and formulation of exercise programs based on results) must be performed by a professional.**

Weight loss measures and exercise based on self-analysis could be harmful to your health. Always follow the advice of a qualified professional.

**This equipment is designated a Class B IT device (mainly for systems intended to be used in indoor environments) and is CE (EMC) certified, but it may affect devices that are sensitive to electromagnetic waves.**



## For Accurate Measurements



Prohibited

### Avoid measuring after strenuous exercise.

This may cause inaccurate measurements. Please take measurements after sufficient rest.



### Avoid measuring after over-eating or over-drinking, or when severely dehydrated.

This may cause inaccurate measurements. For greater accuracy, avoid using directly after waking up. Use at the same time of day each time, at least three hours after the last meal.



**Ensure arms are not touching sides and inner thighs are not touching each other during measurement. If necessary, place a dry towel between arm and side and/or between thighs.**

**Do not take measurements while using transmitting devices such as mobile phones, as these may affect readings.**



Required

### Use the equipment under the same conditions and in the same position as much as possible for accurate tracking of changes.

Readings are affected by the level of hydration and position of the body. Please use at the same time of day each time, under the same conditions and in the same body position.



### Avoid measuring in multiple locations with greatly differing temperatures.

This may cause inaccurate measurements. Allow the equipment to stand for at least 2 hours before using if it is moved to a new location with a temperature difference of 20°C/36°F or more.

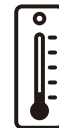

### Place palms and fingers in the correct positions on the electrodes when measuring.

Improper contact between the hands and electrodes may cause the displayed fat percentage to be lower than the actual percentage, or cause an error.

### Hold onto the grip. Be sure to wash your hands first.

Having dirty hands will cause inaccurate measurements.

### Do not sit or bend the elbows or knees.

This causes inaccurate measurements.

### Do not move during measurement.

This causes inaccurate measurements.

### Use in a stable location.

Errors in measurements may occur if the equipment is used in an unstable location.

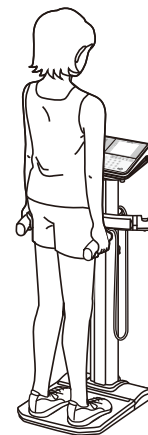

## Note

For people to whom any of the following apply, changes in measurement values should be referred to as a reference.

- People with metal implants
- People taking medications that induce changes in body water (e.g. diuretics, etc.)
- People who are pregnant, on dialysis or experiencing any swelling. The reliability of body fat percentages may decrease.

# For Your Safety (continued)

en

Before Use

## Scheduled Maintenance

**TANITA recommends that each facility conduct periodic checks of each unit.**

1. Check the following at least daily:
  - The unit is on a stable and level surface on a firm flooring, not on a thick carpet
  - Date and time settings
2. Visually inspect the following at least weekly:
  - The display for any damage or contamination
  - All cables, cords, and connector ends for damage or contamination
  - All safety-related labeling for legibility
  - All accessories (electrodes, etc.) for wear or damage
3. Visually inspect the following at least monthly:
  - Mounting screws

**Update settings, replace items, or call for service as necessary according to the results of the visual inspections. Do not use the unit if you see any signs of damage. Equipment that has been damaged must be checked for proper operation by qualified personnel before using again.**

### Incorrect Ways to Measure

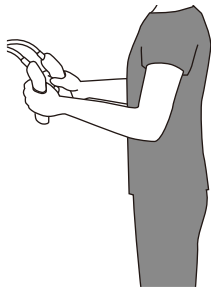

With bent elbows and wrists

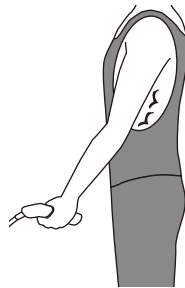

With skin to skin contact

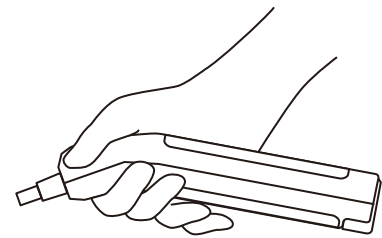

Without all fingers attached to the electrodes

### Contact condition

- **If your inner things are touching or your arms make skin-to-skin contact, the results can only be used as reference data.**

# Checking the Contained Items

## Checking the Contained Items (Platform, Control box, Accessories)

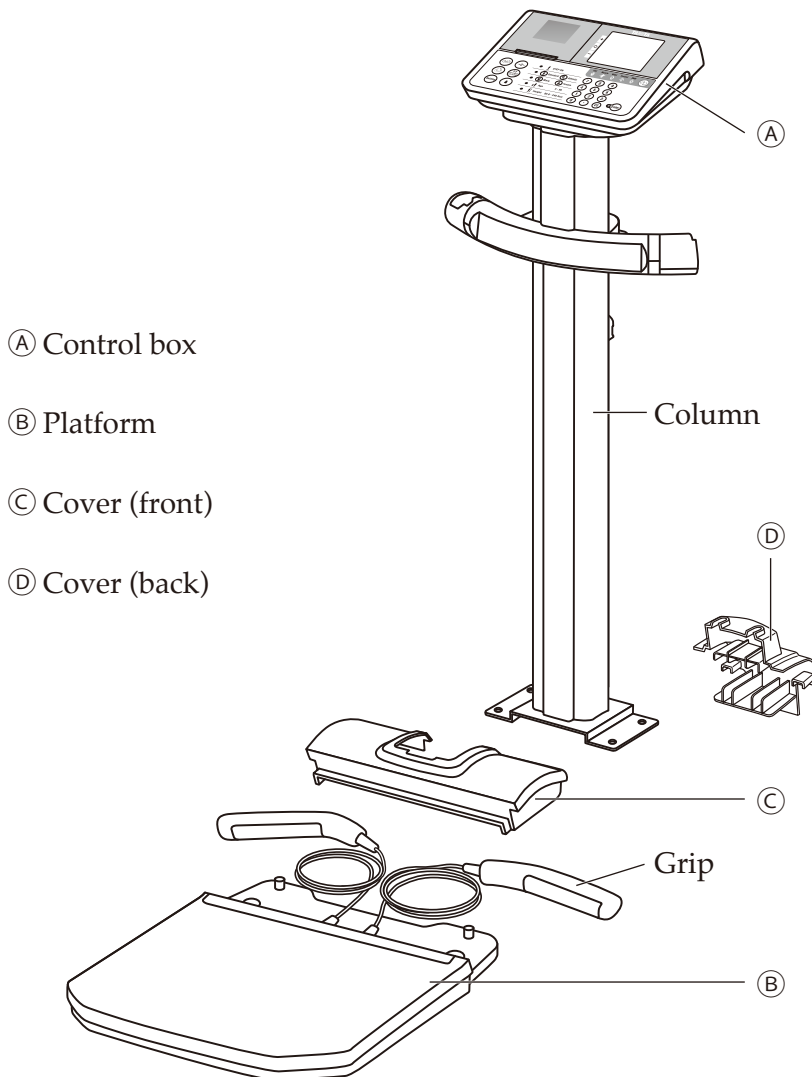

### Accessories

AC adaptor



Assembly Guide

AC cord



Measurement Guide

Screws x 4

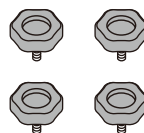

Printer Paper x 1

Mats x 3

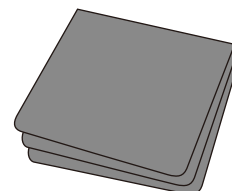

Contact us if you do not have all of the components listed above (See back cover).

# Positioning the Scale/Setting up the Mat

en

Before Use

## Positioning the Scale

### Checking that the equipment is level.

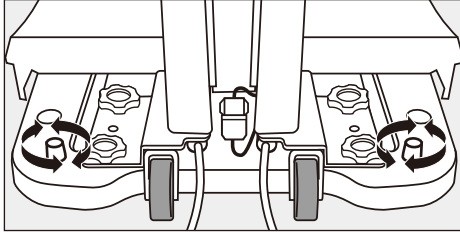

Unfasten the knobs on the platform and stabilize the feet ( $\times 4$ ) and adjustable feet ( $\times 2$ ).

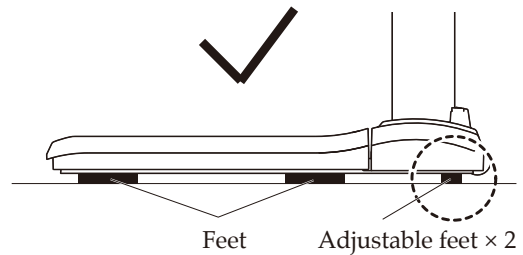
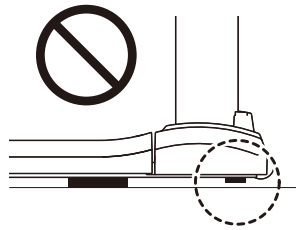
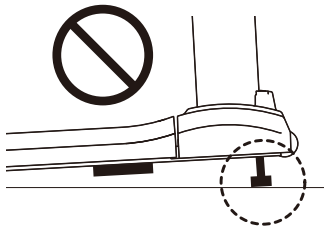

#### Note

For accurate measurements, make the equipment as even as possible.

## Setting up the Mat

You can use the device while wearing your shoes.  
Use the mat to make sure that you do not slip on the platform.  
The mat also protects the device against stains and damage.

1

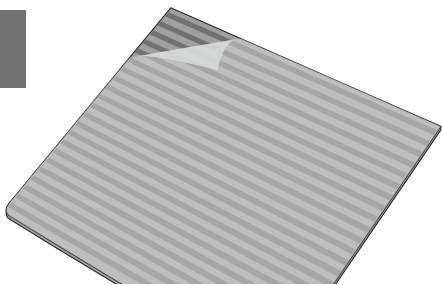

Remove the protective sheet under the mat.

2

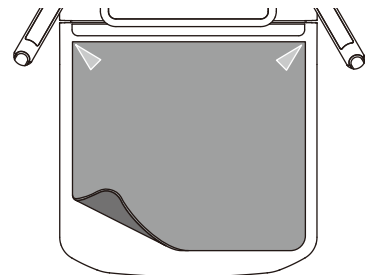

Align the mat with the platform.

#### Note

If the equipment is being used for measurement every day, the mat should be replaced around once a month. If you are unsure about anything, please contact our customer service division.



# Part Names & Connection Procedure

en

Before Use

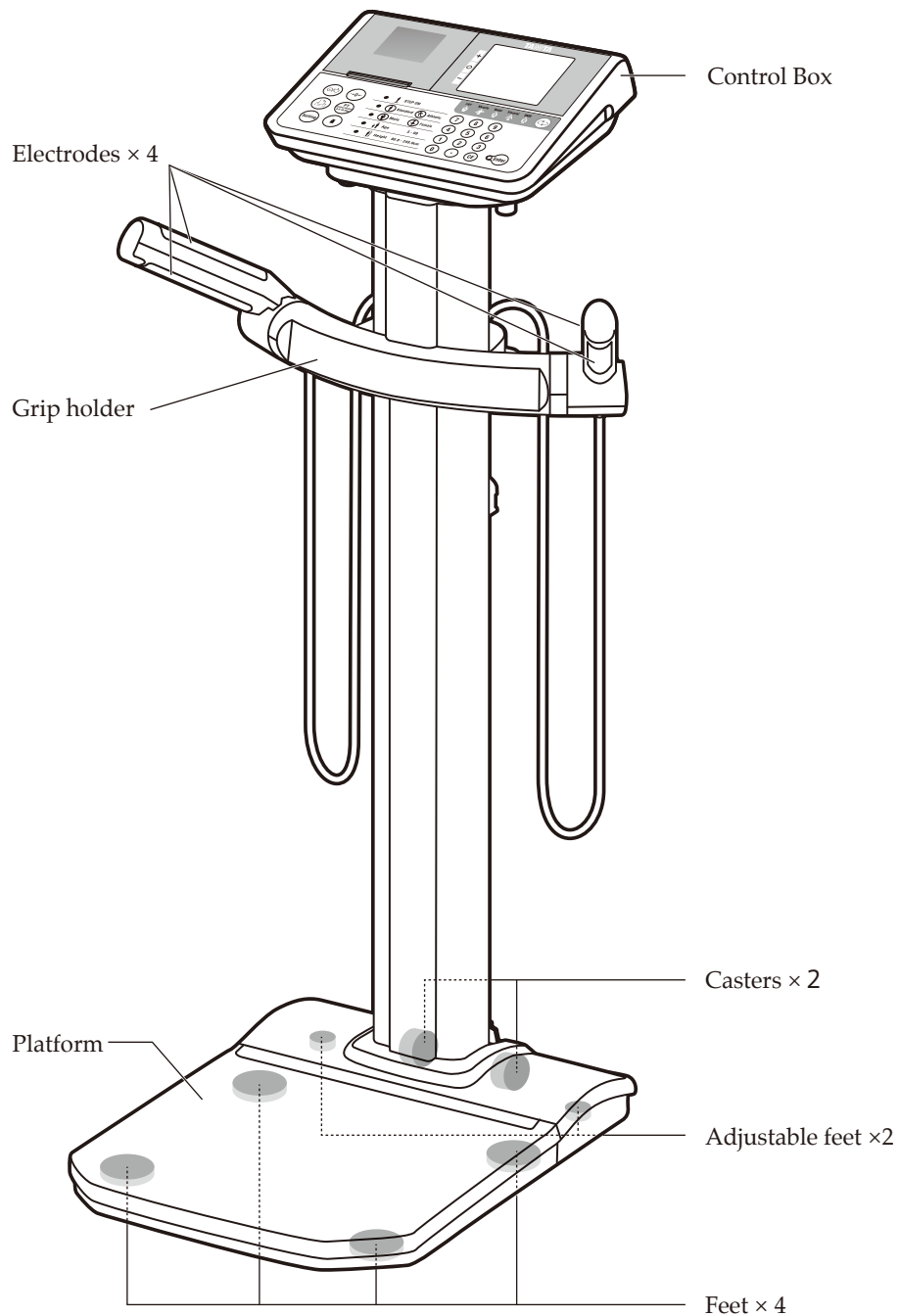

## Symbols and their Meanings

	Positive polarity		SD card		WEEE - Waste Electrical and Electronic Equipment Directives
	Alternating current		Serial interface		For indoor use only
	Input, Output		Direct current		See the instructions
	Caution Refer to the attached notes.		Serial number		Manufacturer
	CE marking				

# Part Names & Connection Procedure (continued)

en

Before Use

## Control Box

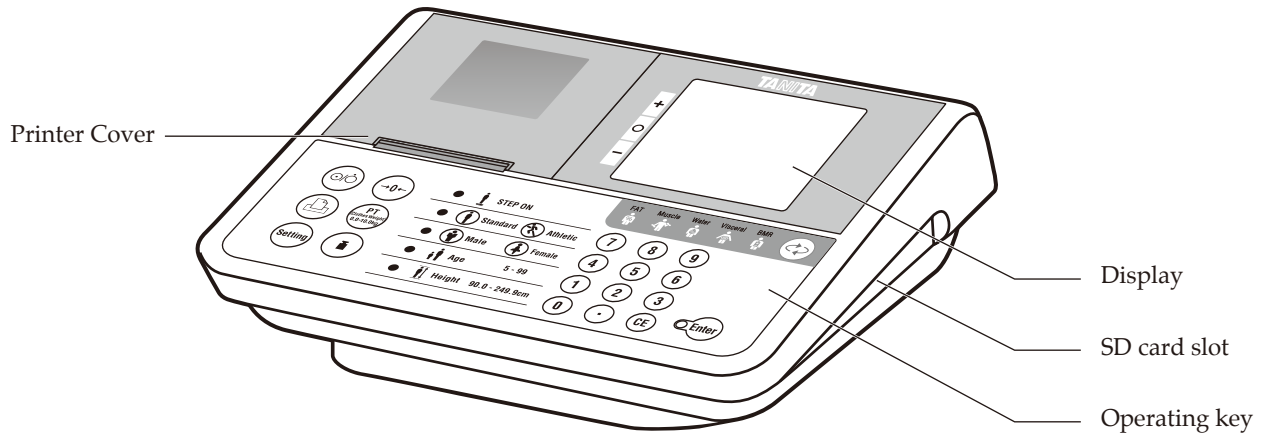

## Connecting the Power

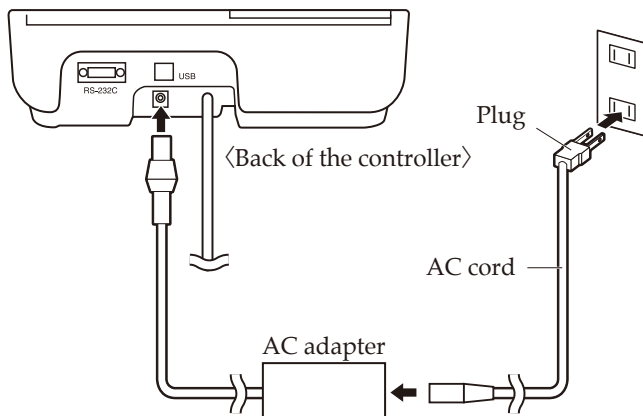

1. Connect the AC adapter to the AC cord and plug the AC adapter into the controller jack.
2. Plug the plug on the AC adapter into the wall socket.

### Warning

Do not have wet hands while handling the plug or AC adapter, as this can cause electrical shocks.

Display and Keys

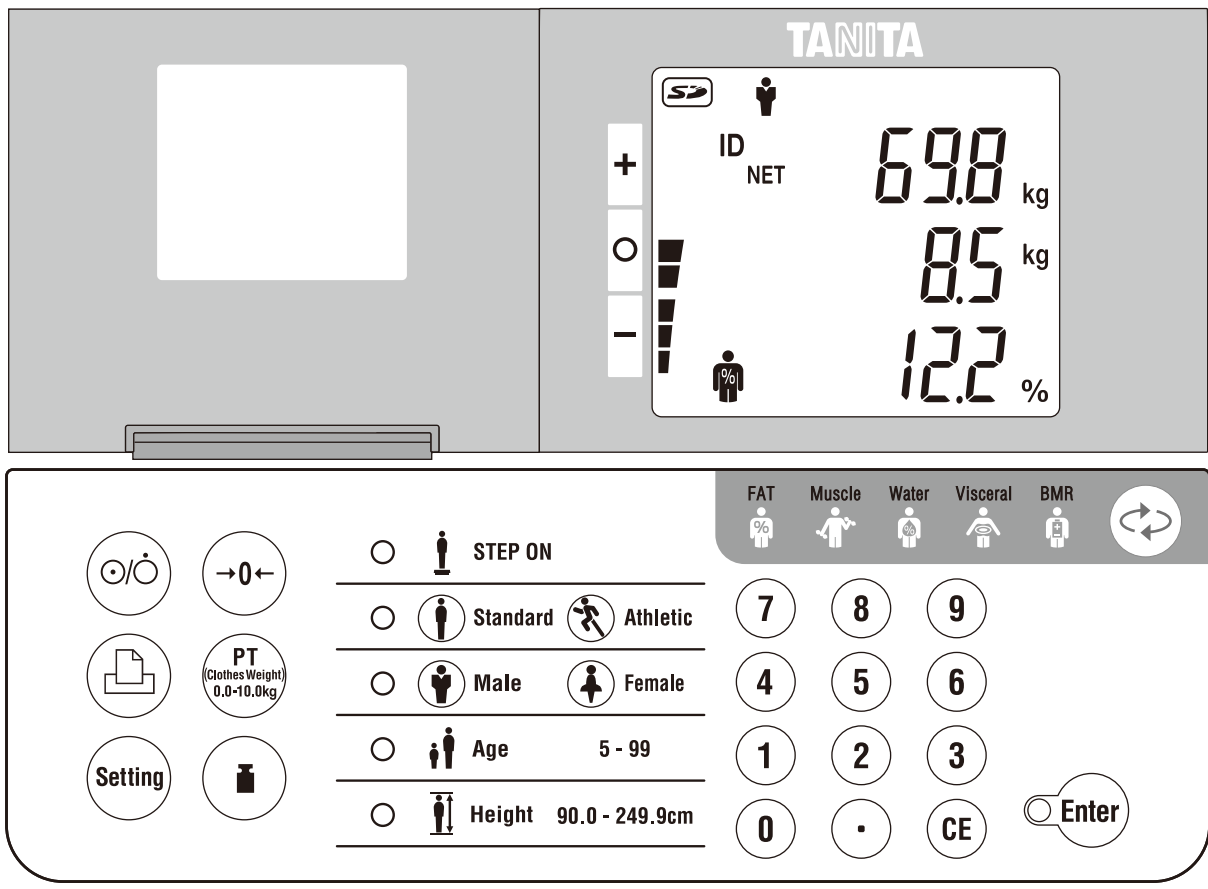

Meanings of the LED Indicators and Keys

	Turn ON / OFF the power
	Feeds the printer paper
	Set various functions
	Reset zero point
	Set preset value (Clothes weight)
	Select measurement mode
	Select measurement display
	SD card

	Display Body Fat (percentage and mass) *Not measured value but calculated value		
	Display Body Muscle (percentage and mass) *Not measured value but calculated value		
	Display Body Water (percentage and mass) *Not measured value but calculated value		
	Display Visceral Fat Rating		Display Basal Metabolic Rate
<input type="radio"/>	Indicate to step on		
<input type="radio"/>	<input type="radio"/>	Select the body type from "Standard mode" or "Athletic mode"	
<input type="radio"/>	<input type="radio"/>	Select the gender from "Male" or "Female"	
<input type="radio"/>	5 - 99	Enter the age between "5 - 99 years"	
<input type="radio"/>	90.0 - 249.9cm	Enter the height between "90.0 - 249.9cm"	
	Confirms the entered numerical value.		

# Setting the Printer Paper

en

Before Use

# 1

(1) Turn the power OFF and push the handle on the left hand side of the controller.

(2) Open the printer cover.

(3) Set the printer paper in place.

Peel off the adhesive and pull out approximately 10cm of printer paper.

(4) Replace the printer cover to its original place.

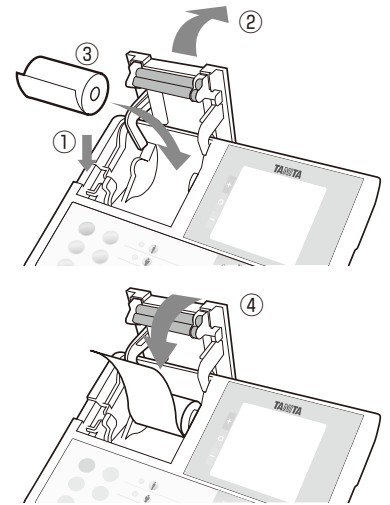

# 2

Press  to turn on the device.

After all the indicators are displayed,  is displayed.

If the device is turned on with the printer cover open,  is displayed.

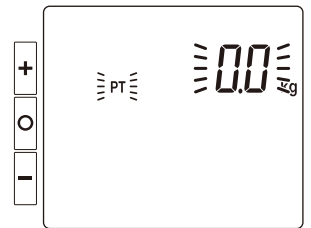

# 3

Press . The printer paper is cut automatically, and the settings are completed.

Paper is not automatically cut when 'Auto Cut' is set to 'Off'.

## Note

Cutting automatically setting → See P.15 Setting item 4

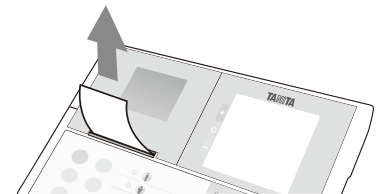

# Setting an SD Card

- 1** When the power is turned OFF, insert an SD card into the slot with the logo side facing upwards.

Make sure the card is facing in the correct direction when inserting it.

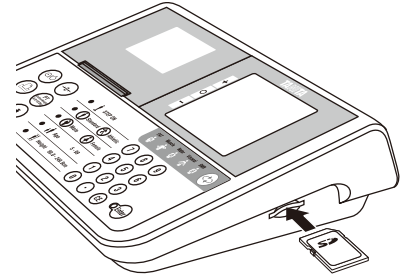

- 2** Press  to turn on the device.

- 3** When the device detects the SD card, the mark on the right appears in the upper left corner of the screen.

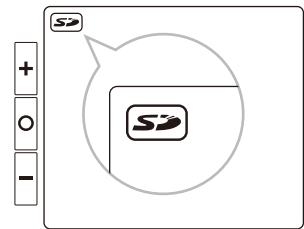

Be sure to insert and remove the SD card when the device power is off to avoid damaging the SD card.

### Note

Compatible with SD and SDHC memory cards  
Not compatible with SDXC memory cards

# Power Supply

en

Before Use

## Turning the Main Power ON/OFF

Turning the main power ON.

Press the  key to turn on the power.

The initial screen is displayed.



Turning the main power OFF.

Press the  key to turn the power OFF.

## Emergency Shut Down

Keep the area around the plug socket clear during operation of the equipment in case of an emergency.

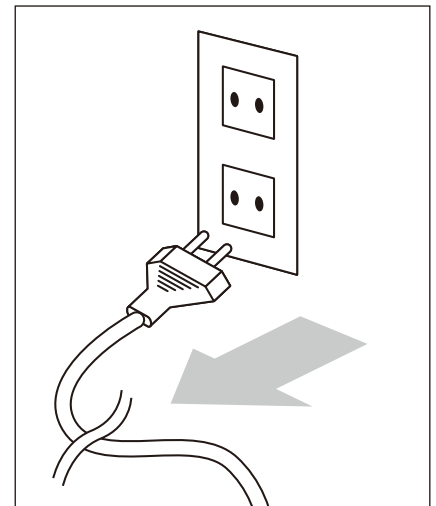



# Settings

**1** Press the  key to change the mode.  
The setting screen is displayed.



**Note**

- The  key cannot be used when the scale is measuring weight or results are displayed while standing on the platform after measurement.

**2** Select the setting item from the list below.  
Enter numerical values and press the  key.

Setting item List  → Save changes and return

 → Correct input number or cancel

No.	Setting item	Default
0	Check the software version	-
1	Date and time → See <b>Note</b> below	2023.11 00:00
2	Number to be printed automatically (0-3 sheet(s))	1
4	Cutting automatically (0: off, 1: on)	1
5	Beep sound (0: off, 1: on)	1
7	ID number (Automatic count up) (0: off, 1: on)	0
8	Measurement flow (0: Two step flow / Measure body weight first, 1: One step flow / Enter personal info first) * Measurement flow → See P. 17	0
9	Body type selection (Athletic mode) (0: off, 1: on) * Athletic mode → See P. 17 & P. 22	1

No.	Setting item	Default
10	Height input unit (0: 0.1cm increments, 1: 1cm increments)	0
11	Automatic determination time of input information (0-9 second(s)) * 0: Disables this function	0
18	Target body fat ratio input (0: off, 1: on)	0
19	Printout Language(1: English, 2: French, 3: German, 4: Italian, 5: Spanish, 6: Dutch, 7: Turkish, 8: Danish, 9: Swedish, 10: Norwegian, 11: Polish)	1
20	Printout contents (1: full, 2: short)	1
21	Timeout function of result display (0: disable, 1: enable)	0
23	BMR kJ unit display (0: off, 1: on)	1
45-69	Printing item settings (0: off, 1: on) → See P. 23	1
80	Reading Stored Measurement Result Data → See P. 26	-

**Note**

Enter the year, month, day, hour and minute.  
The date format is “yyyy mm dd hh:mm”  
(Date input range: 2023 01 01 00:00 - 2099 12 31 23:59)

**Example** 3:45 pm, 10th October, 2023  
“2023” “10 10” “15:45”

To enter a number with 1 digit (0 - 9), press “0” first.

Press the  key again to return to the measurement screen.

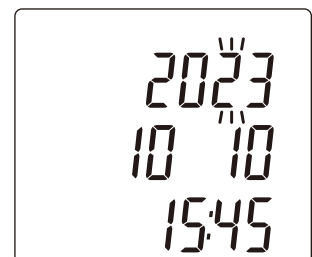

# Settings (continued)

en

Before Use

## Select the Measurement Mode

Select the measurement mode by pressing the  key.

The measurement mode is switched in the following order when the  key is pressed:

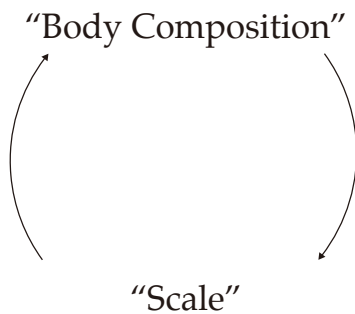

The  mark is displayed when the scale mode is selected.

### Body Composition Mode

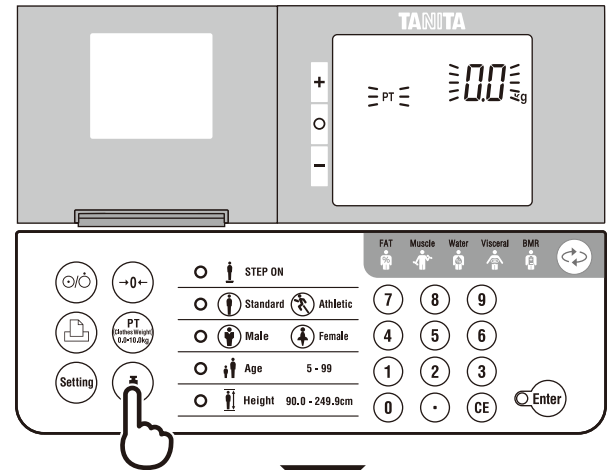

### Scale Mode

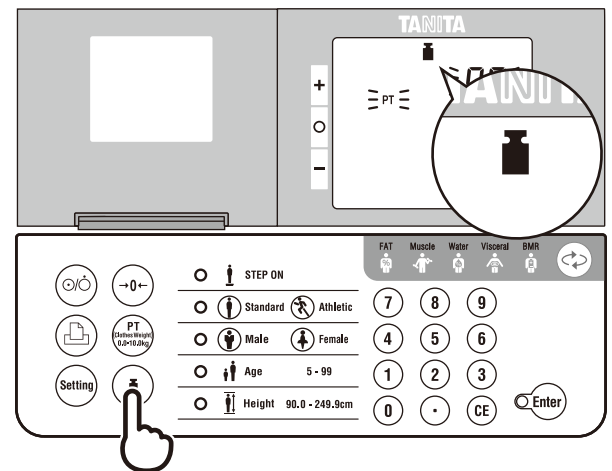



# Taking a Measurement

## Body Composition Mode (Two step flow Measure body weight first)

### 1 Set the clothes weight after 0.0kg is displayed.

Set the clothes weight after 0.0kg is displayed. When undertaking measurements with your shoes on, count the weight of the shoes toward the clothes weight (0.0 - 10.0kg).

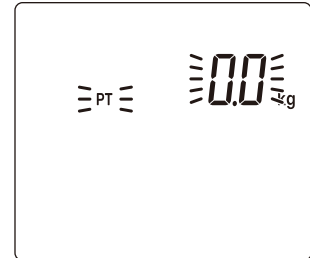

Standard clothes weight: summer 1.0kg, winter 2.0kg  
Standard shoes weight:



\*The weight is based on the standards as researched by Tanita.

### 2 Enter ID number.

If the ID number function is set to OFF, the scale switches directly to "Measure body weight" without requesting an ID number. If the ID number is set to ON, ID number will be increased automatically. To change ID number manually, press **CE** and enter the preferred ID number.  
The ID number range: 0 - 9999999999999999

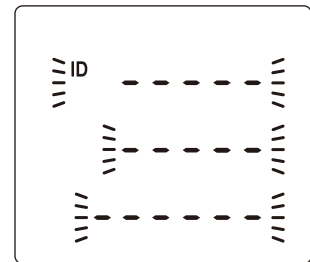

**Note** ID number setting → See P.15 Setting item 7

### 3 Measure body weight.

Step onto the platform, after "STEP on" flashes.  
"NET" is displayed when you have entered a tare value (clothes weight).  
The "Stabilised" icon (●) appears when the load is stable.

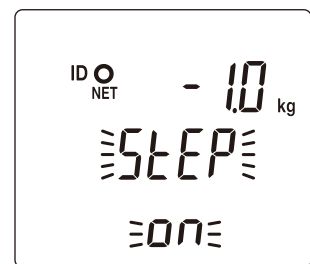

**Note**  
When the One step flow is selected, enter personal information first.  
→ See P.15 Setting item 8

If the scale does not detect a load, press **PT** (Clothes Weight 0.0-10.0kg) to switch to "Input tare value".  
If the scale detects the load, press **PT** (Clothes Weight 0.0-10.0kg) to display the entered tare value.

### 4 Select body type. Standard Athletic

If the body type selection (Athletic mode) is set to OFF, the scale switches directly to "Select gender" without requesting a body type.  
The "⚡" mark is displayed when the Athletic mode is selected.

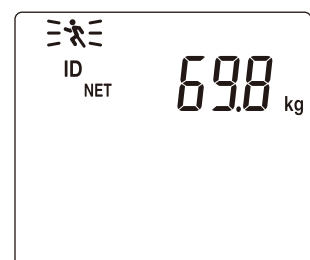

**Note** Athletic mode setting → See P.15 Setting item 9  
Athlete condition → See P.22

# Taking a Measurement (continued)

en

How to Use

## Body Composition Mode

**5** Select gender.  Male  Female

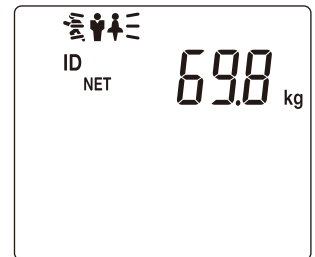

**6** Enter age.  Age

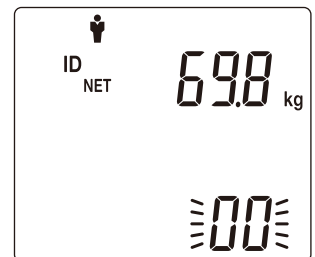
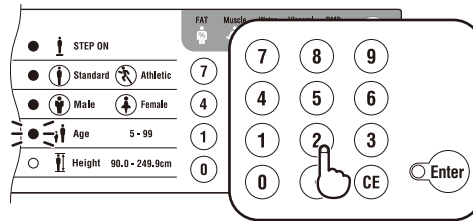

The age range: 5 - 99

**7** Enter height.  Height

The height range:  
90.0 - 249.9cm

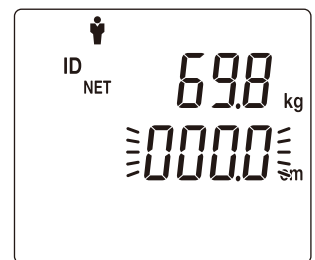
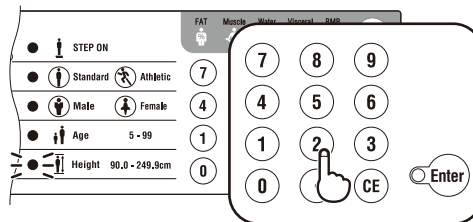

**Note** Height input unit setting → See P.15 Setting item 10

**8** Set target body fat ratio.

If the target body fat ratio function is set to OFF, the scale switches directly to “Measuring impedance” without entering the target value.

The body fat ratio range: 4 - 55%

**Note** Target Body Fat ratio input → See P.15 Setting item 18

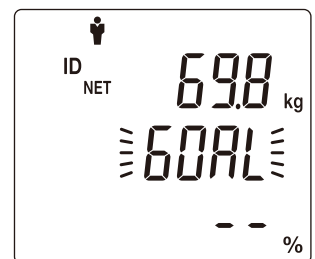

**9** Measure body composition.

The scale starts measuring impedance after you have entered all of the personal information. Wait until “gr IP on” is displayed, and remain standing while measuring.

The measurement is complete when all “000000” disappear. The scale displays the measurement results after measuring the whole body impedance.

The next measuring starts by pressing .

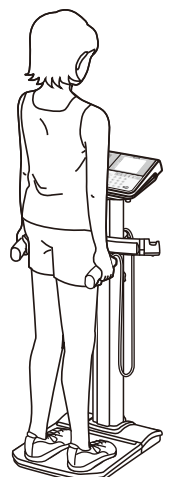
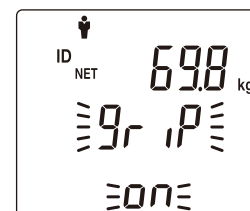

# Measurement Results

## Output Measurement Results (Body Composition Mode)

The measurement results are displayed on the LCD after measurement is completed.

The results are printed immediately after measurement is completed.

Press the  key to select the measurement display.

The measurement display is switched in the following order by pressing the  key.

→ "Fat" → "Muscle" → "Body Water" → "Visceral fat rating" → "Basal metabolic rate" → "BMI" →

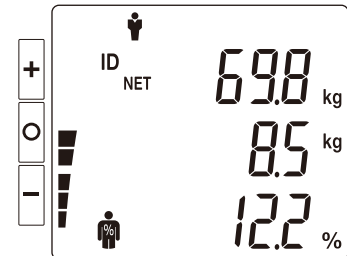

### **Body Fat** (Applicable age: 5 - 99)

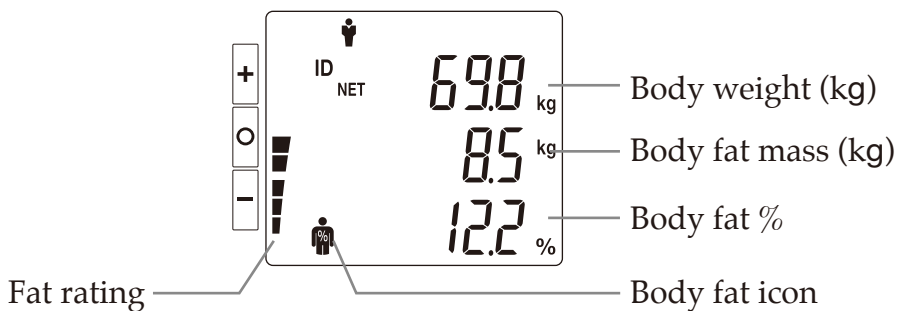

### **Muscle** (Applicable age: 18 - 99)

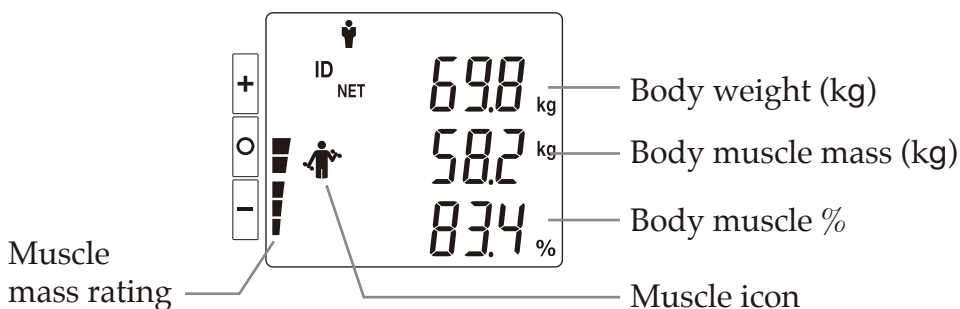

\*Muscle mass level compared to the general population.

# Taking a Measurement (continued)

en

How to Use

## Measurement Results

### Total Body water (Applicable age: 5 - 99)

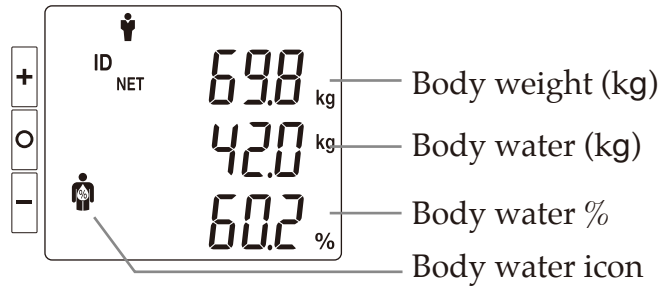

### Visceral fat rating (Applicable age: 18 - 99)

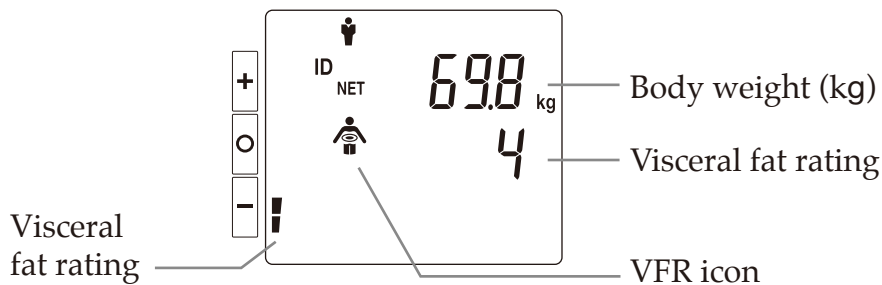

### Basal metabolic rate (Applicable age: 5 - 99)

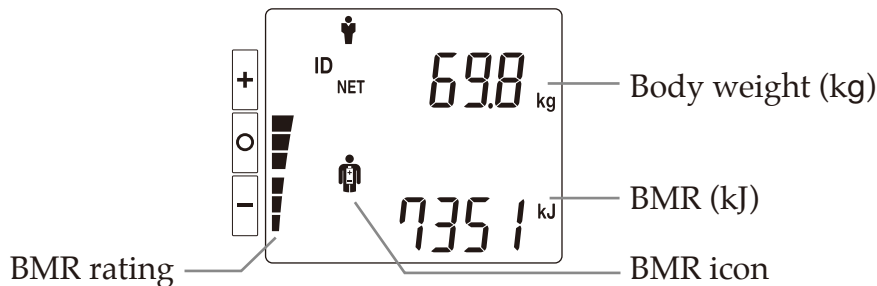

\*Basal metabolic rate level compared to the general population.

**Note** BMR kJ unit display ON/OFF setting → See P.15 Setting item 23

### Body Mass Index (BMI) (Applicable age: 5 - 99)

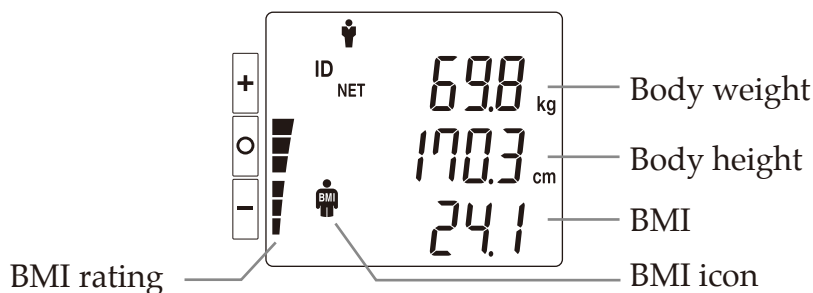

“O” flashes if measuring posture is incorrect.  
The results can only be used as reference data. → See P.28



# Scale Mode

The **PT** icon is displayed when the scale mode is selected.

## 1 Set the clothes weight after 0.0kg is displayed .

Set the clothes weight after 0.0kg is displayed.  
When undertaking measurements with your shoes on, count the weight of the shoes toward the clothes weight (0.0 - 10.0kg).

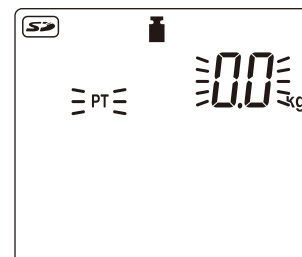

Standard clothes weight: summer 1.0kg, winter 2.0kg  
Standard shoes weight:



Pumps  
0.2kg



Running shoes  
0.5kg



Sneakers  
0.7kg



Leather shoes  
1.0kg



Boots  
2.5kg

\*The weight is based on the standards as researched by Tanita.

## 2 Enter the ID number

If the ID number function is set to OFF, the scale starts measuring weight immediately.  
If the ID number is set to ON, ID number will be increased automatically.

To change ID number manually, press **CE** and enter the preferred ID number.

The ID number range is from 0 - 9999999999999999.

Press **PT** (Standard Weight 0.0-10.0kg) to enter tare value (clothes weight).

The tare value range is 0.0 - 10.0kg.

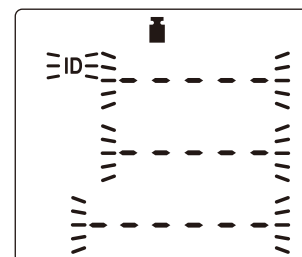

### Note

ID number setting → See P.15 Setting item 7

## 3 Measure body weight.

Step onto the platform, after "StEP on" flashes.

"NET" is displayed when you have entered a tare value (clothes weight).

Set the clothes weight after 0.0kg is displayed.

When undertaking measurements with your shoes on, count the weight of the shoes toward the clothes weight (0.0 - 10.0kg).

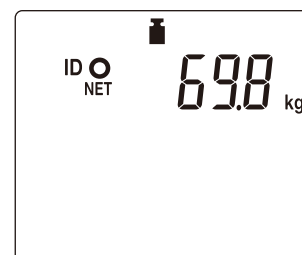

# Output and Storage of Measurement Results

en

How to Use

## General Instructions for Body Composition Measurement

### Athletic Mode

- **Recommended for those who are 18 years or older and meet the following conditions.**
  - People who carry out 12 or more hours of general or cardiovascular exercise a week.
  - People who belong to a sport team or a sport organization with the aim of participation in competition, etc.
  - People who are professional athletes.
  - People who are undertaking training such as bodybuilding to increase their muscle mass.

### Target Body Fat

- **A target body fat % should be set by a professional only. Tanita is not responsible for setting the appropriate target body fat % for specific individuals.**

### Attention

- **Posture when measuring.**
  - Stand with both feet parallel on the electrodes.
  - Stand without bending knees.
- **The age input range is 5 – 99 years old.**  
**Input age 99 for those who are 100 years or older.**

### Note

- Inaccurate results may be reported after excessive food/fluid intake, or after periods of intense exercise.
- If clothes weight is input, clothes weight is subtracted from the weight measurements.

## Select Printing Data

- 1 Press the  key to change the mode.  
The setting screen is displayed.



### Note

The  key cannot be used when the scale is measuring weight or results are displayed while standing on the platform after measurement.

- 2 Select the printing item from the list below.

Select the No. of the item that you want to change, select whether printing is on or off, and press .

## Printing Data 0: off, 1: on

No.	Items	Default	No.	Items	Default
45	Fat Mass	1.on	58	Desirable Range	1.on
46	Fat Free Mass	1.on	59	Total Body Water %	1.on
47	Muscle Mass	1.on	60	Indicator Fat %	1.on
48	Total Body Water Mass	1.on	61	Indicator BMI	1.on
49	Bone Mass	1.on	62	Indicator Visceral Fat Rating	1.on
50	Basal Metabolic Rate (BMR)	1.on	63	Indicator Muscle Mass	1.on
51	Metabolic Age	1.on	64	Indicator BMR	1.on
52	Visceral Fat Rating	1.on	66	Physique Rating	1.on
54	BMI	1.on	67	Bioelectrical Data	1.on
56	Ideal Body Weight	1.on	68	TANITA Logo	1.on
57	Degree of Obesity	1.on	69	Muscle Mass %	1.on

Press the  key again to return to the measurement display.

# Output and Storage of Measurement Results (continued)

en

## Lists of Contents of the Print Item Preset

How to Use

Print item	Body composition analyzer						Scale
	Full			Short			
Body Type	Standard	Athletic	Child	Standard	Athletic	Child	
TANITA LOGO	✓	✓	✓	✓	✓	✓	✓
Category Name	✓	✓	✓	✓	✓	✓	✓
Model Number	✓	✓	✓	✓	✓	✓	✓
Date and Time	✓	✓	✓	✓	✓	✓	✓
ID No	*1	*1	*1	*1	*1	*1	*1
Body Type	✓	✓		✓	✓		
Gender	✓	✓	✓	✓	✓	✓	
Age	✓	✓	✓	✓	✓	✓	
Height	✓	✓	✓	✓	✓	✓	
Clothes Weight	✓	✓	✓	✓	✓	✓	✓
Weight	✓	✓	✓	✓	✓	✓	✓
Fat %	✓	✓	✓	✓	✓	✓	
Fat Mass	✓	✓	✓				
Fat Free Mass	✓	✓	✓				
Muscle Mass	✓	✓					
Muscle Mass %	✓	✓					
Total Body Water	*3	*3	*3				
Total Body Water %	*3	*3	*3				
Bone Mass	✓	✓					
Basal Metabolic Rate	✓	✓	✓				
Metabolic Age	✓	✓					
Visceral Fat Rating	✓	✓					
BMI	✓	✓	✓	✓	✓	✓	
Ideal Body Weight	✓						
Degree of Obesity	✓						
Desirable Range	✓	✓	✓				
Target Body Fat %	*2	*2	*2	*2	*2	*2	
Indicator Fat %	✓	✓	✓				
Indicator BMI	✓	✓					
Indicator Visceral Fat Rating	✓	✓					
Indicator Muscle Mass	✓	✓					
Indicator BMR	✓	✓					
Physique Rating	✓	✓					
Bioelectrical Data	✓	✓	✓	✓	✓	✓	
Contact condition	✓	✓	✓	✓	✓	✓	

See P.25 for an example of preset print.

\*1: These items are not default.

\*2: If Target Body Fat % is on, and if the Target Body Fat % has been input, it will print out.

\*3: Total Body Water will not print if there is an error.



# In the Case to Select the Print Item Preset

All items can be printed in Standard Mode.

\*In the Case to Select the Print Item Preset

**Weight**

- Measured weight.

**Fat %**

- Fat % is amount of body fat as a proportion of body weight.

**Fat mass**

- Total weight of fat mass in the body.

**FFM**

- Fat Free Mass is comprised of muscle, bone, tissue, water, and all other fat free mass in the body.

**Muscle mass/Muscle mass %\***

- Bone-free lean tissue mass (LTM)

**TBW/TBW %**

- Total Body Water is the amount of water retained in the body. TBW is said to comprise between 50 - 70% of total body weight. Generally, men tend to have higher water weight than women due to a greater amount of muscle.

**Bone mass\***

- Bone mineral amount included in the entire bone.

**BMR**

- Basal Metabolic Rate represents the total energy expended by the body to maintain normal functions at rest such as respiration and circulation.

**Metabolic age\***

- Metabolic age is evaluated young when a muscular amount is larger, and BMR is higher.

**Visceral fat rating\***

- Visceral fat rating feature indicates the rating of visceral fat.

**BMI**

- Calculated with "weight (kg) / height(m)<sup>2</sup>"

**Ideal body weight\***

- Ideal body weight is a value for which the BMI is 22.

**Degree of obesity\***

- Calculated as (weight - Ideal body weight) / Ideal body weight × 100.

\*18 - 99 years old only

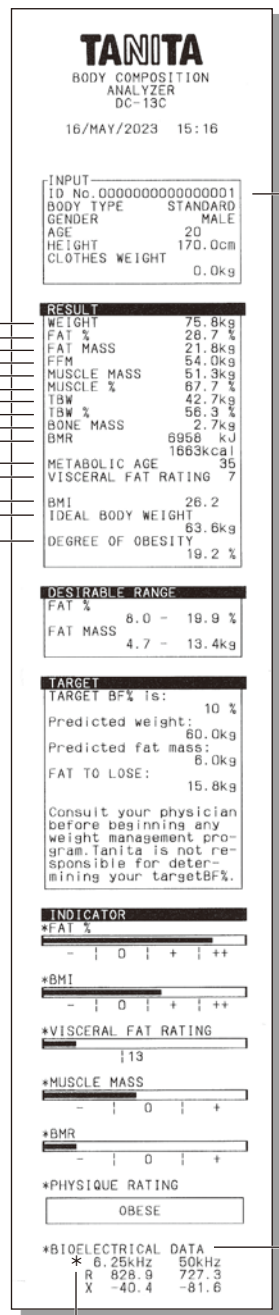

For those who are 17 years old or younger, only the body fat % is displayed as the standard value. The muscle mass and total body water for those who are 17 years old or younger are for reference.

**⚠ Please consult your doctor before you start a body weight management program. TANITA is not responsible for the target body fat ratio.**

**ID**

- When it is set with an ID, it is printed out. (The default is without an ID.)

**Bioelectrical data**

- The table indicates Resistance(R)/Reactance(X) data.

**Contact condition mark**

- When this mark is printed out it means that your posture during measurement was incorrect. The results can only be used as reference data.

# Output and Storage of Measurement Results (continued)

en

## Reading Stored Measurement Result Data

How to Use

- 1 Press the  key while the display is on, and select the setting 80.

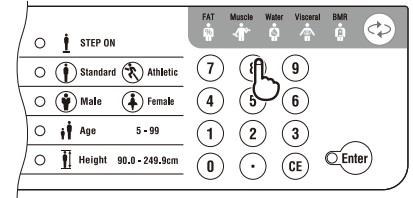

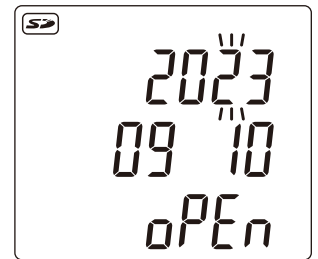

Make sure the SD card is inserted.  
Enter the measurement date (YYYYMMDD)  
using the keypad, then press the Enter key  
and "oPEn" lights.

When there is no data matching with the  
entered date, "F-nonE" is displayed.



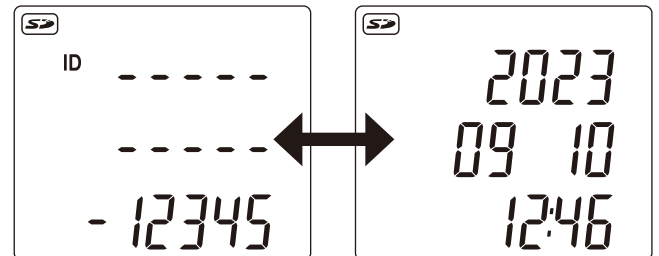

- 2 When a file is present, the ID and  
measurement data and time of the  
data saved at the beginning of the  
file are alternately displayed.

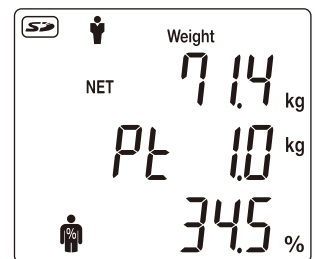

- (1) Press the  key, and the ID  
and measurement date and time of the data  
saved below are alternately displayed.



- (2) Press the  key, and Body weight,  
Pt (Clothes weight) and Body Fat % are displayed.  
\*Press the  key to return to one higher level.

# Data Output

## Outputting measurement results via the USB or RS

The results are output to the PC immediately after measurement is completed.

Data is output in CSV format.

- USB connector (Type B 4 - pin female) and RS-232C are located on the back of the control box.
- Please provide your own cable as necessary as none are included.  
USB cable: Type A 4 - pin (male) - Type B 4 - pin (male)
- Please install the necessary driver on your PC. Drivers can be downloaded from:  
<https://www.tanita.eu/>
- RS-232C and USB are mutually exclusive.

# Data Storage

## Data storage of measurement results

The results are saved to the SD card immediately after measurement is completed.

The  icon is displayed when a valid SD card is inserted.

A new file is created on the SD card for each day.

The file is created using the measurement date and time as the file name, as shown below. "YYYYMMDD" (year, month and date)

If "Sd-F" is shown in the display, this indicates that there is not enough free space left on the SD card.

- Do not remove the SD card when it is storing or reading data.
- Do not turn off the main power when the SD card is storing or reading data.

\*Compatible with SD and SDHC memory cards. Not compatible with SDXC memory cards.

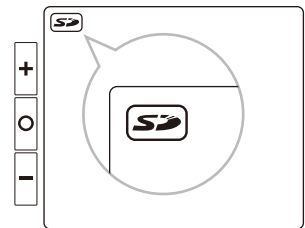

# Troubleshooting

en

Please check the following before requesting repair.

If Necessary

	Problem	Solution
Measurement	Error with impedance measurement "Err40" is displayed.	<ul style="list-style-type: none"> <li>Stand barefoot on the platform for measurement.</li> <li>If the soles of the feet are dry, use a dropper to apply about 0.5 mL of water before measurement.</li> <li>Check the input details.</li> </ul>
	Error with zeroing "uuuuu" is displayed.	<ul style="list-style-type: none"> <li>Turn off the power and remove anything on the platform, then turn on the power and try measuring again.</li> </ul>
	The weight value does not stabilize.	<ul style="list-style-type: none"> <li>Is the equipment placed on a vibrating surface?</li> <li>Is the measuring platform tilted?</li> <li>Is something blocking the gap in the measuring platform?</li> <li>Remove any inserted objects.</li> </ul>
Display	Nothing is displayed, even when the power is turned on.	<ul style="list-style-type: none"> <li>Confirm that the power is connected correctly.</li> </ul>
	"-----" is displayed.	<ul style="list-style-type: none"> <li>The measured weight exceeds weighing capacity.</li> </ul>
	"○" flashes.	<ul style="list-style-type: none"> <li>"○" flashes if measuring posture is incorrect. The results can only be used as reference data. → See P.6</li> </ul>
Printer	Run out of print paper "P-End" is displayed.	<ul style="list-style-type: none"> <li>Printer paper is not supplied. ⇒ Supply paper. ⇒ In the case that the printer is not used, press CE key and redo the initial setting.</li> </ul>
	Printer cover open "COPEn" is displayed.	<ul style="list-style-type: none"> <li>The printer cover is open. ⇒ Properly close it. ⇒ Check that the printer paper is not slanted.</li> </ul>
SD card	"Sd-F" is displayed.	<ul style="list-style-type: none"> <li>Insufficient space on the SD card. ⇒ Transfer or delete data from the SD card.</li> </ul>
	"Sd-P" is displayed. or "Sd-E" is displayed.	<ul style="list-style-type: none"> <li>An SD memory card drive error might have occurred. ⇒ Turn off the power off and on. ⇒ Format the SD memory card. ⇒ The device might be damaged.</li> </ul>

# Specifications

en

If Necessary

<b>Model Number</b>		DC-13C
<b>Power Source</b>		100 – 240V AC
<b>Rated power</b>		36VA
<b>Impedance Measurement</b>	<b>Measurement System</b>	Dual-frequency 4 electrode
	<b>Measurement Frequency</b>	6.25kHz / 50kHz
	<b>Electrode Materials</b>	Plastic plated
	<b>Measurement Part</b>	Between both hands
	<b>Measurement Range</b>	150.0 – 1,500.0Ω (0.1Ω increments)
	<b>Accuracy at First Calibration</b>	±2%
<b>Weight Measurement</b>	<b>Measurement System</b>	Strain gauge load cell
	<b>Range</b>	2.0 – 270.0kg (including preset tare value)
	<b>Minimum Graduation</b>	0.1kg
	<b>Accuracy at First Calibration</b>	±0.2kg
<b>Display</b>		LCD screen
<b>Interface</b>		USB B-type connector (device)
		RS-232C
		SD card
<b>Usage Conditions Range</b>	<b>Temperature</b>	5 – 35°C
	<b>Relative Humidity</b>	30 – 80% (without condensation)
<b>Storage Conditions Range</b>	<b>Temperature</b>	-10 – +60°C
	<b>Relative Humidity</b>	10 – 90% (without condensation)
<b>Product Weight</b>		12kg
<b>Product Size</b>		D400mm×H1027mm×W568mm – D603mm×H1027mm×W568mm

\*Compatible with SD and SDHC memory cards. Not compatible with SDXC memory cards.

# Specifications (continued)

en

If Necessary

Input Items	<b>Clothes Weight</b>	0.0 – 10.0kg (0.1kg increments)
	<b>ID No.</b>	16 digits
	<b>Gender</b>	Female / Male
	<b>Body Type</b>	Standard / Athletic * <sup>1</sup>
	<b>Age</b>	5 – 99 years
	<b>Height</b>	90.0 – 249.9cm (0.1cm increments)
	<b>Target Body Fat %</b>	4 – 55% (1% increments)
Output Items	<b>ID No.</b>	16 digits
	<b>Gender</b>	Female / Male
	<b>Body Type</b>	Standard / Athletic * <sup>1</sup>
	<b>Age</b>	5 – 99 years
	<b>Height</b>	90.0 – 249.9cm (0.1cm increments)
	<b>Clothes Weight</b>	0.0 – 10.0kg (0.1kg increments)
	<b>Weight</b>	2.0 – 270.0kg (0.1kg increments)
	<b>Fat %</b>	3.0 – 75.0% (0.1% increments)
	<b>Fat Mass</b>	0.1kg increments
	<b>FFM</b>	0.1kg increments
	<b>Muscle Mass *<sup>2</sup></b>	0.1kg increments
	<b>Muscle Mass % *<sup>2</sup></b>	0.1% increments
	<b>Muscle Mass Rating *<sup>2</sup></b>	1 – 24 (1 increments)
	<b>BMI</b>	0.1 increments
	<b>Bone Mass *<sup>2</sup></b>	0.1kg increments
	<b>Basal Metabolic Rate (BMR)</b>	1kcal / 1kJ increments
	<b>BMR Rating *<sup>2</sup></b>	1 – 24 (1 increments)
	<b>Metabolic Age *<sup>2</sup></b>	1 year increments
	<b>Visceral Fat Rating *<sup>2</sup></b>	1 – 59 (1 increments)
	<b>TBW</b>	0.1kg increments
	<b>TBW %</b>	0.1% increments
	<b>Physique Rating *<sup>2</sup></b>	9 ratings
	<b>Ideal Body Weight *<sup>2</sup> *<sup>3</sup></b>	0.1kg increments
<b>Degree of Obesity *<sup>2</sup> *<sup>3</sup></b>	0.1% increments	
<b>Target Body Fat %</b>	1% increments	
<b>Bioelectrical Data</b>	Resistance / Reactance	
<b>Contact Condition *<sup>4</sup></b>		

\*1: Athletic mode can be selected only 18 – 99 years old

\*2: 18 – 99 years old

\*3: Athletic mode will not be output.

\*4: The results can only be used as reference data.



This product meets the following requirements;

1. EMC Directive (2014/30/EU)
2. RoHS Directive (2011/65/EU)

- The product design and specifications may be changed at any time without prior notice.
- SD Logo, SDHC Logo and SDXC Logo are trademarks of SD-3C LLC.

## Disposal



This product is an electronic device. Please dispose of this product appropriately, not as general household waste. Be sure to follow the regulations in your area when disposing of this product.

### Manufacturer

#### TANITA Corporation

1-14-2 Maeno-cho, Itabashi-ku, Tokyo  
174-8630 Japan  
TEL: +81-(0)3-3968-7048  
[www.tanita.co.jp](http://www.tanita.co.jp)

### EU Representative

#### TANITA Europe B.V.

Hoogoorddreef 56-E, 1101 BE  
Amsterdam, the Netherlands  
TEL: +31-(0)20-560-2970  
FAX: +31-(0)20-560-2988  
[www.tanita.eu](http://www.tanita.eu)

### TANITA Corporation of America, Inc.

2625 South Clearbrook Drive,  
Arlington Heights, Illinois 60005 U.S.A.  
TEL: +1-847-640-9241  
FAX: +1-847-640-9261  
[www.tanita.com](http://www.tanita.com)

### TANITA Health Equipment H.K. Ltd.

Unit 301-303, Wing On Plaza, 3/F., 62 Mody Road,  
Tsimshatsui East, Kowloon, Hong Kong  
TEL: +852-2834-3917  
FAX: +852-2838-8667  
[www.tanita.asia](http://www.tanita.asia)

### TANITA (Shanghai) Trading Co., Ltd.

Room 8005, 877 Huai Hai Zhong Lu, Shanghai,  
The People's Republic of China  
TEL: +86-21-6474-6803  
FAX: +86-21-6474-7901  
[www.tanita.com.cn](http://www.tanita.com.cn)

### UK Representative

#### TANITA Europe B.V.

111 Piccadilly, Manchester, M1 2HY, UK  
TEL: +44-161-6380926  
[www.tanita.eu](http://www.tanita.eu)